



⚠ WARNING!



Be sure to read and fully understand this document before installing, operating, maintaining or servicing this appliance. Failure to do so can result in appliance failure, property damage, serious injury or death. Appliance failure, injury or property damage due to improper installation is not covered by warranty.

! USER ACTION!

TRUE tracks the history of your appliance by its serial number. For easy reference, record your appliances full model name and serial number below. This information is on your serial label. Serial label location varies by appliance.

Model Name:

Serial Number:

True Manufacturing Co., Inc.

2001 East Terra Lane • O'Fallon, Missouri 63366-4434
(636) 240-2400 • FAX: (636)-272-2408

International FAX: (636)-272-7546 • (800)-325-6152

Parts Department: (800)-424-TRUE (424-8783)
Parts Department FAX: (636)-272-9471



INSTALLATION MANUAL

TRUE ICE-TCIM

Original Instructions

Contact Us

Warranty Phone: +1 855-299-3510
Warranty Email: CommercialIceWarrantyInquiries@truemfg.com
Technical Phone: +1 888-783-1429
Technical Email: CommercialIce@truemfg.com



THANK YOU

FOR YOUR PURCHASE

Congratulations!

The primary purpose of this document is to assist the installation, maintenance, and servicing of your TRUE appliance. This document contains information important to safety, operation, maintenance, and servicing. **DO NOT** discard this document. True is solely the appliance manufacturer. For assistance finding a qualified technician, please visit our Service Company Locator at truemfg.com/support/service-locator/.

NOTICE!	
	<p>Figures might not exactly match your appliance.</p>

Contents

Installation & Setup Checklist

Installation & Setup Checklist 3

Preface

Signal & Symbol Definitions 4

Important Safety Information

Basic Safety & Operation Warnings 6

Personal Injury Warnings 7

Hydrocarbon Refrigerant Warnings 9

Ice Machine Disposal Warnings 9

Electrical Safety Warnings 10

About Your Ice Machine & Installation Requirements

Model Nomenclature 13

Ice Machine Specifications 14

Label Locations 15

Cube Size 16

Basic Screen & Icon Definitions 17

Plan Views 18

Plumbing Connection Requirements 23

Water Filter Setup 26

Electrical Requirements 27

Installation & Setup

Ice Machine Location 30

Uncrating 30

Panel Removal 31

Interior Inspection 31

Ice Storage Bin or Dispenser 32

Leveling 33

Antenna & Modem Installation 34

Dispenser Bracket 36

Ice Level Sensor Setup 36

Initial Sanitizing 38

Installation & Setup Checklist 39

Ice Machine Operation

Control Display Modes & Operation 40

Basic Screen & Icon Definitions 42

Reset Reminders 48

Adjust Reminder Settings 48

Startup 50

Adjust Ice Thickness 50

Sequence of Operation 52

Schedule Operation 53

Adjust for Water Quality 55

Cleaning Navigation 56

Maintenance & Servicing

Removal from Service & Winterization 59

Cleaning the Ice Level Sensor 60

TrueZone™ Air & Surface Clean-In-Place (CIP) System... 60

Recommended Cleaning Frequency 62

Exterior Cleaning 64

Descaling & Sanitizing Procedures (biannually) 64

Preventative Maintenance Descaling & Sanitizing Procedure 70

Troubleshooting 73

Warranty

Warranty 76

Installation & Setup Checklist

- Have you connected the modem wires and antenna as shown on pg. 34?
- Have you enabled the TOF sensor and set the ice storage bin as shown on pg. 36?
- Is the ice machine level?
- Is the ice machine located where the ambient temperature is within 35°-110°F (1.7°- 43.3°C) and the water temperature within 35°-110°F (1.7°-43.3°C) all year around?
- Does the ice machine have the proper clearance for air circulation and service? See "Ice Machine Specifications" (pg. 14).
- If present, are the air filter and blank cover installed on the correct side to meet clearance requirements?
- Have all shipping materials been removed from the ice machine's exterior and interior?
- Is the ice machine on a dedicated electrical circuit?
- Have all electrical and water connections been made?
- Do electrical and water connections meet applicable laws, codes, and regulations?
- Has the power supply voltage been checked or tested against the nameplate rating?
- Has a proper ground been installed to the ice machine?
- Are the water supply and drain lines sized as specified (pg. 23)?
- Are the shut-off valve(s) and drain valve(s) installed?
- Is the water supply pressure between 20-100 psig (138-689 kPa)?
- Is the compressor snug on all mounting pads?
- Have the refrigerant lines been checked to ensure they do not rub or touch other lines or surfaces?
- Has the fan blade (if applicable) been checked to ensure it turns freely?
- Has the end user been given the instruction manual, as well as instructed on how to operate the ice machine and the importance of the recommended periodic maintenance?
- Has the end user been given the contact information for an authorized service agent?
- Has ice machine and bin/dispenser been sanitized per the manufacturer's instructions?
- Is the drain line vented?

Preface

The warning, guidelines, and recommendations within this document are meant to prevent appliance damage, injury, or death. Please carefully read all warnings, guidelines, and recommendations before proceeding to ensure the continued safe use and maintenance of your TRUE ice machine.

Signal & Symbol Definitions



Below are symbols you may see in this document. Some symbols may not appear.



Signal Word Definitions	
DANGER!	An imminently hazardous situation which, if not avoided, will result in serious injury or death.
WARNING!	A potentially hazardous situation which, if not avoided, can result in serious injury or death.
CAUTION!	A potentially hazardous situation which, if not avoided, may result in minor or moderate injury; an unsafe practice.
USER ACTION!	User action alert, follow all recommendations to avoid appliance or product damage.
NOTICE!	Important information not related to hazards or risk of personal injury.

Safety Symbols	
	Safety alert; alerts reader to potential physical injury hazards. Obey all safety messages following this symbol to avoid possible injury or death.
	Flammable material; fire or explosion hazard.
	Electrical shock hazard.
	Earth terminal must be grounded.
	Tipping hazard; tip-over hazard.
	Sharp element; cut or sever hazard.

Safety Symbols	
	Crush or cut hazard.
	Slippery surface hazard.
	Optical radiation hazard; risk of eye and skin injury.
	Corrosive substance hazard.
	Toxic material hazard.
	Moving parts hazard.

Preface

Additional Symbols	
	Mandatory action alert symbol; alerts reader to required or recommended actions. Obey all messages and recommendations following this symbol to avoid appliance or product damage.
NOTICE >	Important information not related to hazards or risk of personal injury.
	Review and understand the installation manual before installing, operating, or servicing.

Additional Symbols	
	Wear eye protection .
	Wear protective gloves .
	DO NOT dispose of with other household waste.

Important Safety Information

Important Safety Information

Basic Safety & Operation Warnings

Follow basic safety precautions, including the following, to reduce risk of personal injury, electric shock, fire, or death.

WARNING!

Be sure to read and fully understand this document before installing, operating, maintaining, or servicing this ice machine. Failure to do so can result in appliance DAMAGE OR failure, property damage, LOSS OF WARRANTY, serious injury, or death. Appliance failure, personal injury, or property damage due to improper installation is not covered by warranty.

- Failure to install, operate, and maintain the ice machine as detailed in this document will negatively affect safety, appliance performance, component life, and warranty coverage.
- The ice machine must be installed in accordance with all applicable laws, codes, and regulations.
- All utility connections and fixtures must be maintained in accordance with all applicable laws, codes, and regulations.
- The manufacturer cannot be held responsible for injury or damage resulting from improper, incorrect, and unreasonable use.
- This appliance is not to be used, cleaned, or maintained by persons (including children) with reduced physical, sensory, or mental capabilities or lack of experience and knowledge, without proper supervision or instruction.
- **DO NOT** install or operate equipment that has been misused, abused, neglected, damaged, or altered/modified from original manufactured specifications.
- **DO NOT** modify or alter the ice machine. Improper alterations can result in electric shock, personal injury, fire, or death.
- The appliance owner is responsible for performing a Personal Protective Equipment (PPE) Hazard Assessment and to ensure adequate protection during maintenance and cleaning procedures.
- Use appropriate tools, safety equipment, and PPE during installation and servicing.
- Only use the appliance for its intended purpose as described in this document. Failure to do so may result in equipment damage, personal injury, or death.
- Keep the area surrounding the appliance clean to avoid appliance damage from debris or pests.
- All covers, and access panels must be in place and properly secured when operating the ice machine.
- Maintain all minimum clearances. See "Ice Machine Specifications" (pg. 14). **DO NOT** obstruct vents or openings.





Important Safety Information (cont.)



Personal Injury Warnings

Only qualified technicians should install and service the appliance. For assistance finding a qualified technician, please visit our Service Company Locator at truemfg.com/support/service-locator/. TRUE is solely the appliance manufacturer and is not responsible for installation.

⚠ DANGER!







	<p>DO NOT allow children to play with or in the appliance. Child entrapment or personal injury can occur.</p>
	<p>Flammable Refrigerant and High Voltage Electricity. Installations and repairs must be performed by qualified technicians aware of the dangers associated with refrigerant under pressure and high voltage electricity. Follow all lockout and tag out procedures when working on this equipment.</p>
	<p>DO NOT store or use the following in the vicinity of this or any other appliance:</p> <ul style="list-style-type: none"> • Gasoline or other flammable vapors and liquids • Combustible or explosive substances, such as aerosol cans with a flammable propellant • Flammable oil-soaked cloths or combustible cleaning solutions for cleaning • Other volatile or flammable substances • Open flame source

⚠ WARNING!

	<ul style="list-style-type: none"> • Only qualified technicians should install and service your ice machine. • Turn off and lockout all utilities (gas, electric, water) according to approved practices during maintenance or servicing. • Use appropriate tools, safety equipment, and personal protective equipment (PPE) during installation and servicing. • DO NOT touch the cold surfaces in the evaporator compartment when hands are damp or wet. Skin may stick to extremely cold surfaces. • Choke Hazard! Ensure all components and fasteners are securely in place after installation. Be sure no objects have fallen into any dispenser unit or ice storage bin; immediately remove any objects.
	<p>This product can expose you to chemicals including Di-(2-Ethyl hexyl) Phthalate (DEHP), which is known to the State of California to cause cancer and birth defects or other reproductive harm. For more information go to P65warnings.ca.gov.</p>
	<p>Slippery Surfaces! Moisture from improper drainage can create slippery surfaces near the ice machine. It is your duty to immediately warn your customers of, and dry, the slippery surface. All wet floor areas must be marked with a wet floor sign.</p>

Important Safety Information (cont.)

⚠ WARNING! (cont.)

	<p>Sharp Edges!</p> <p>Take care when moving, installing, cleaning, servicing, and maintaining the ice machine to avoid cuts. Be sure to take care when reaching under the appliance or handling metal components.</p> <ul style="list-style-type: none"> • Stay clear of pinch point areas, such as the space between appliance doors and surrounding cabinetry. Take care closing doors with children nearby.
	<p>Crush or Cut Hazard!</p> <p>Keep clear of moving components. Components can move without warning unless power is disconnected.</p>
	<p>Optical Radiation Hazard! UV Light!</p> <p>Invisible laser radiation. Do not look directly at light. Always disconnect power before servicing the lamp.</p>
	<p>Tip Over Hazard!</p> <p>Appliance may pose a tipping hazard when uncrating, installing, or moving the appliance. Take appropriate safety precautions. Use of tip over restraints may only reduce (not eliminate) the tipping hazard. Never allow children to climb or hang on drawers, doors, or shelves.</p>
	<p>Risk of Electric Shock or Burn!</p> <p>See "Electrical Safety Warnings" for more information.</p>
	<p>Moving Parts Hazard!</p> <p>Moving parts can cut. Keep hands clear when panels are removed.</p>



Important Safety Information (cont.)

Hydrocarbon Refrigerant Warnings

TRUE appliances use hydrocarbon refrigerant (R-290/513A/600a). Check the nameplate or rating label to identify the ice machine's refrigerant. See "Label Locations" (pg. 15).

⚠ DANGER!	
	<p>Risk of Fire or Explosion! Flammable Refrigerant Used.</p> <ul style="list-style-type: none"> Models may contain up to 300 grams of R290 (propane) refrigerant. R290 (propane) is flammable in concentrations of air between approximately 2.1% and 9.5% by volume (LEL lower explosion limit and UEL upper explosion limit). An ignition source at the temperature higher than 878°F (470°C) is needed for a combustion to occur. All servicing and maintenance must be performed by qualified technicians. This is to minimize the risk of fire or personal injury due to incorrect parts or improper service. DO NOT damage the refrigeration system during transportation, installation, maintenance and servicing. If the ice machine is damaged, verify the refrigeration system's integrity is not compromised before proceeding. Never use sharp objects or tools to remove ice or frost. DO NOT use mechanical devices to accelerate defrost. Dispose of in accordance with all applicable laws, codes, and regulations. Follow all safety precautions associated with handling flammable refrigerant.





Ice Machine Disposal Warnings

⚠ DANGER!	
  	<p>Risk of Fire or Explosion!</p> <ul style="list-style-type: none"> Flammable refrigerant and insulation used. Dispose of in accordance with all applicable laws, codes, and regulations. Follow all safety precautions associated with handling flammable refrigerant and insulation. DO NOT dispose of your appliance with household waste.

Important Safety Information (cont.)

Electrical Safety Warnings

⚠ DANGER!

	<p>High Voltage Inside! Open circuit voltage and voltage to ground 600v.</p>
   	<p>Risk of Electric Shock, Burn, or Fire!</p> <ul style="list-style-type: none"> It is the appliance owner's responsibility to ensure the electrical connection meets all applicable building codes. Failure to meet these code requirements can result in appliance damage, fire, electric shock or burns, serious personal injury, or death. All field wiring must conform to all applicable codes of the authority having jurisdiction. It is the responsibility of the end user to provide the disconnect means to satisfy local codes Before connecting your Ice machine to the power supply, verify the supply voltage and circuit rating match the nameplate and rating labels. Correct improper supply voltage or circuit size immediately. See "Label Locations" (pg. 15). Before connecting your ice machine to the power supply, verify the power supply is correctly grounded. If the power supply is not grounded, correct immediately. TRUE recommends hiring a qualified electrician to inspect your electrical circuit to ensure they are properly grounded. For personal safety, your ice machine must be properly grounded. The ice machine should receive power from its own individual dedicated electrical circuit. This provides the best performance and prevents overloading the power supply. Toggling the rocker switch does not remove power from all components. Unplug the ice machine or turn off the power supply before installation or servicing. This equipment must be positioned so that the plug is accessible unless other means for disconnection from the power supply (e.g., circuit breaker or disconnect switch) are provided Check all wire connections, including factory terminals, before operation. Connections can become loose during shipment and installation. DO NOT clean appliance with a pressure washer or hose. DO NOT immerse power cord in water. Never use a damaged power supply. DO NOT operate any appliance with a damaged power supply. Repair a damaged power supply immediately. All repairs must be performed by a qualified service company.

ⓘ NOTICE!

	<p>TRUE will not warranty the following:</p> <ul style="list-style-type: none"> Compressor failures due to improper incoming voltage. <p>For more details, see TRUE's full warranty statement. Find a copy of the wiring diagram with our Serial Number Lookup at truemfg.com/support/serial-number-lookup.</p>
--	---

About Your Ice Machine & Installation Requirements

About Your Ice Machine & Installation Requirements

NOTICE!



True is not responsible for damage incurred during shipment. Always carefully inspect for freight damage before receiving and installing your appliance. If there is damage, note all damage on the delivery receipt, immediately file a claim with the delivery freight carrier, and contact True. **Do not install the unit or put it in service.**

Thank you for choosing True Manufacturing to meet your refrigeration needs. True highly recommends a qualified technician and electrician install your ice machine to ensure correct installation. The cost of professional installation is money well spent. Only qualified technicians should install and service the appliance.

For assistance finding a qualified technician, please visit our Service Company Locator at:

truemfg.com/support/service-locator/

True is solely the appliance manufacturer and is not responsible for installation.

Proper installation, care and maintenance are essential for maximum performance and trouble-free operation of your equipment. The appliance owner is responsible for proper installation and maintaining the ice machine as described in the document. Routine care and maintenance procedures are not covered by True's warranty. Visit our website for manual updates and translations:

truemfg.com/support/manuals/

About Your Ice Machine & Installation Requirements (cont.)

Model Nomenclature

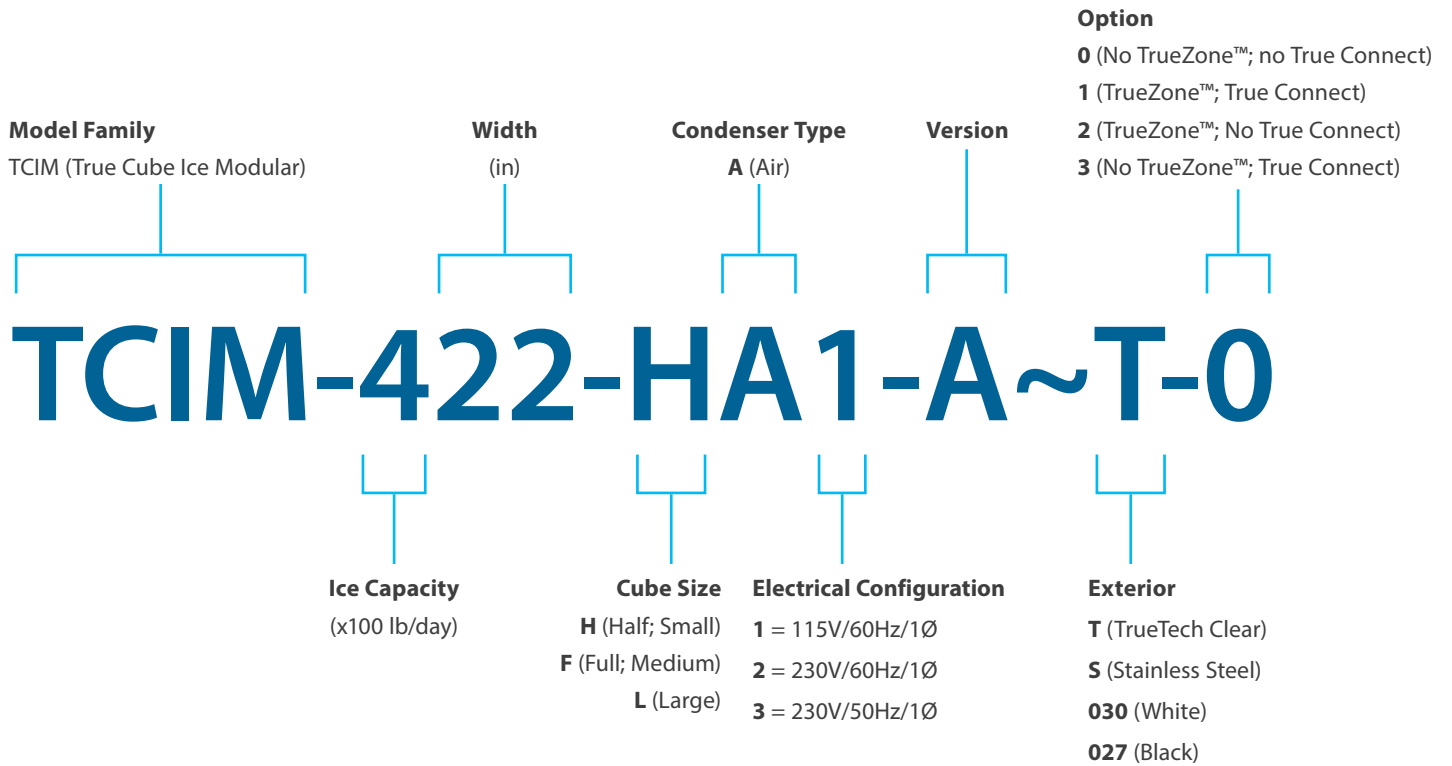

Fig. 1. TCIM model nomenclature diagram.

About Your Ice Machine & Installation Requirements (cont.)

Ice Machine Specifications

Air-Cooled Ice Machine Specifications*

Model	24 Hour Production		Min./Max. Batch Weights	Potable Water Consumption (90°F Air/ 70°F Water)	Electrical Consumption (90°F Air/ 70°F Water)	Peak Heat of Rejection
	70°F Air/50°F Water	90°F Air/70°F Water				
TCIM-422	450 lb (204 kg)	395 lb (179 kg)	3.7–4.6 lb (1.7–2.1 kg)	14.0 gal/100 lb	4.47 kwh/100 lb	5700 BTU/hr (1.67 kW)
TCIM-430	450 lb (204 kg)	385 lb (175 kg)	3.7–4.6 lb (1.7–2.1 kg)	14.0 gal/100 lb	4.27 kwh/100 lb	5800 BTU/hr (1.70 kW)
TCIM-522	550 lb (249 kg)	485 lb (220 kg)	4.7–5.6 lb (2.1–2.5 kg)	14.0 gal/100 lb	4.19 kwh/100 lb	7600 BTU/hr (2.23 kW)
TCIM-530	590 lb (268 kg)	489 lb (222 kg)	4.7–5.6 lb (2.1–2.5 kg)	14.0 gal/100 lb	3.92 kwh/100 lb	7400 BTU/hr (2.17 kW)
TCIM-622	630 lb (286 kg)	544 lb (247 kg)	4.7–5.6 lb (2.1–2.5 kg)	14.0 gal/100 lb	4.15 kwh/100 lb	8500 BTU/hr (2.49 kW)
TCIM-630	630 lb (286 kg)	556 lb (252 kg)	4.7–5.6 lb (2.1–2.5 kg)	14.0 gal/100 lb	3.95 kwh/100 lb	8500 BTU/hr (2.49 kW)
TCIM-822	830 lb (376 kg)	715 lb (324 kg)	5.5–6.3 lb (2.5–2.9 kg)	14.0 gal/100 lb	4.65 kwh/100 lb	10200 BTU/hr (2.99 kW)
TCIM-830	830 lb (376 kg)	715 lb (324 kg)	5.5–6.3 lb (2.5–2.9 kg)	14.0 gal/100 lb	4.5 kwh/100 lb	10200 BTU/hr (2.99 kW)

*Specifications are based on half (small) cube models.

Air-Cooled Ice Machine Clearances

Model	Sides	Top	Back
TCIM-422	6" (152.4 mm)	6" (152.4 mm)	6" (152.4 mm)
TCIM-430	3" (76.2 mm)	6" (152.4 mm)	6" (152.4 mm)
TCIM-522	6" (152.4 mm)	6" (152.4 mm)	6" (152.4 mm)
TCIM-530	3" (76.2 mm)	6" (152.4 mm)	6" (152.4 mm)
TCIM-622	3" (76.2 mm)	12" (304.8 mm)	6" (152.4 mm)
TCIM-630	3" (76.2 mm)	6" (152.4 mm)	6" (152.4 mm)
TCIM-822	6" (152.4 mm)	6" (152.4 mm)	6" (152.4 mm)
TCIM-830	3" (76.2 mm)	6" (152.4 mm)	6" (152.4 mm)

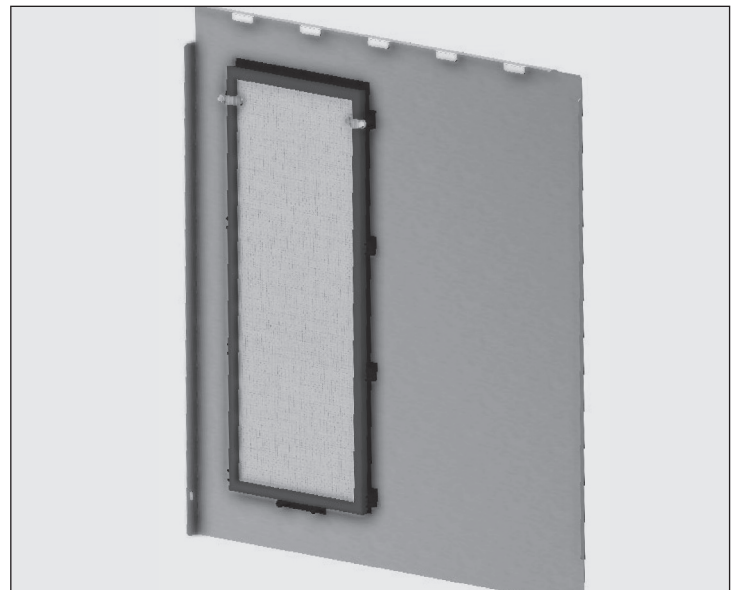

Fig. 1. Interior view of side panel with air filter. Right side shown.

About Your Ice Machine & Installation Requirements (cont.)

Ice Machine Specifications (cont.)

- Ice Machine is not suitable for outdoor use.
- Before connecting your ice machine to the power supply, verify the incoming voltage ($\pm 5\%$) and the amps match the operation ratings on the appliance's nameplate and rating labels. Correct improper incoming voltage or amps immediately. See "Label Locations" (pg. 15) and "Cord Specifications" (pg. 29).
- Before connecting your ice machine to the power supply, verify the power supply is correctly grounded. If the power supply is not grounded, correct immediately.
- Ensure the installation location will provide adequate clearances and sufficient airflow for the ice machine. See "Ice Machine Specifications" (pg. 14).
- Read and follow all warnings and maintenance instructions. Failure to do so may result in damage and void the warranty on your appliance.
- Do not locate the equipment near any heat source, direct sunlight, areas with high ambient conditions or without proper clearance for ventilation. Placing equipment in these locations will result in reduced capacities, high system pressures and may cause equipment failure.
- This ice machine will pull air in from the front/sides and exhaust air out the back. See fig. 2. This ice machine will also reverse fan motor periodically to remove dirt from the condenser coil.

Label Locations

The nameplate and rating labels contain important information such as your model name, serial number, and refrigerant type.

- Locate the nameplate label on the lower left inside wall of the ice machine.
- Locate the rating label on the rear panel.

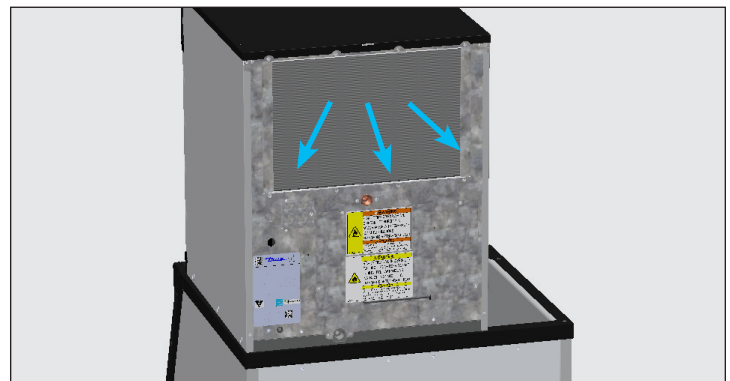
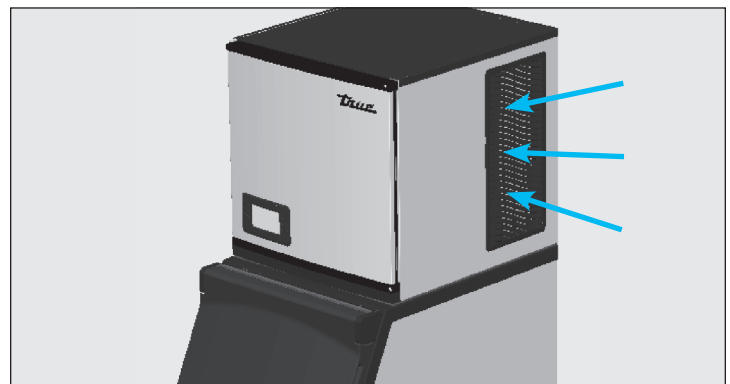
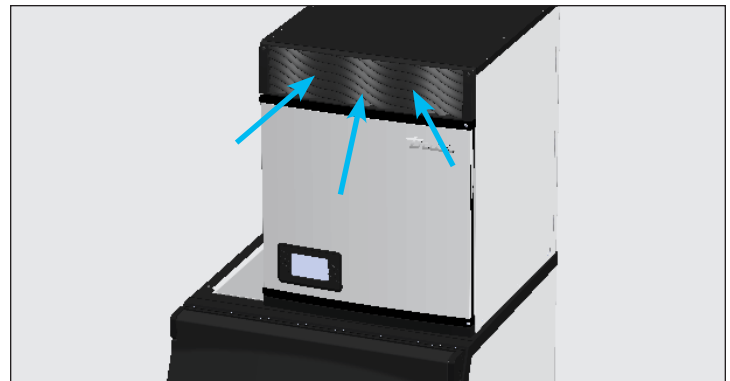

Fig. 2. Air flows into the front/sides and out the rear.

About Your Ice Machine & Installation Requirements (cont.)

Cube Size

TRUE Ice Machines produce ice in three different cube sizes: Half (small), full (medium), and large. The cube size is part of your full model name. See dimensions in fig. 1.

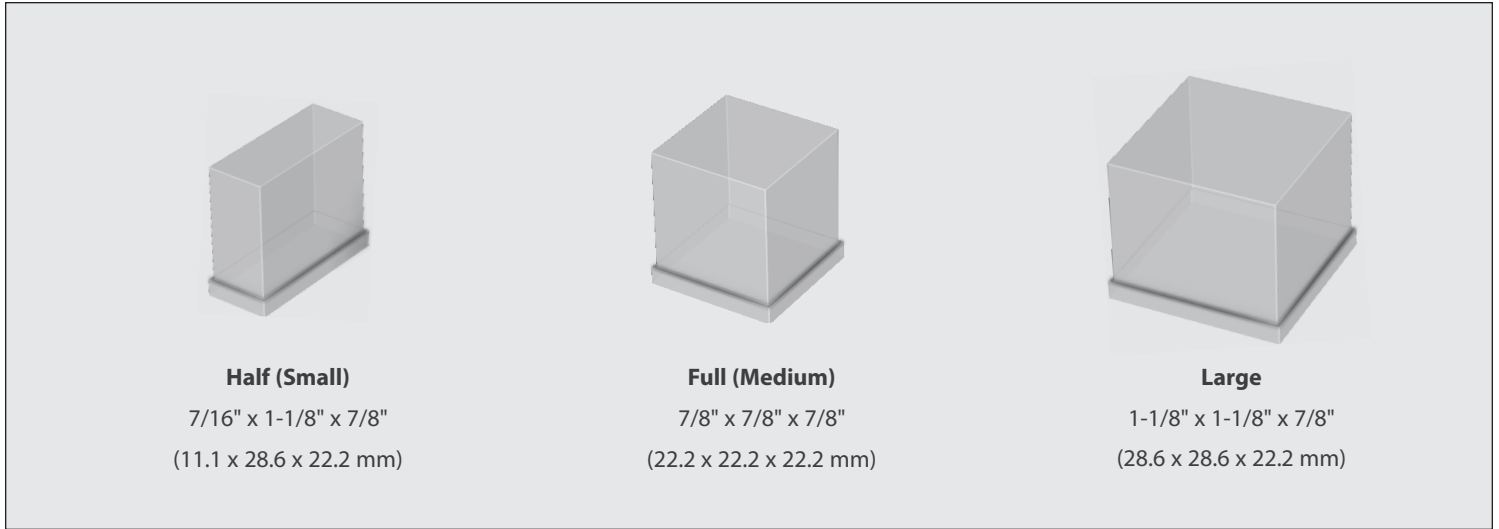

Fig. 1. Cube sizes and their dimensions.

About Your Ice Machine & Installation Requirements (cont.)

Basic Screen & Icon Definitions

For more information on screen and icon definitions, see "Control Display Modes & Operation" (pg. 41).

Home Screen

The default display screen.

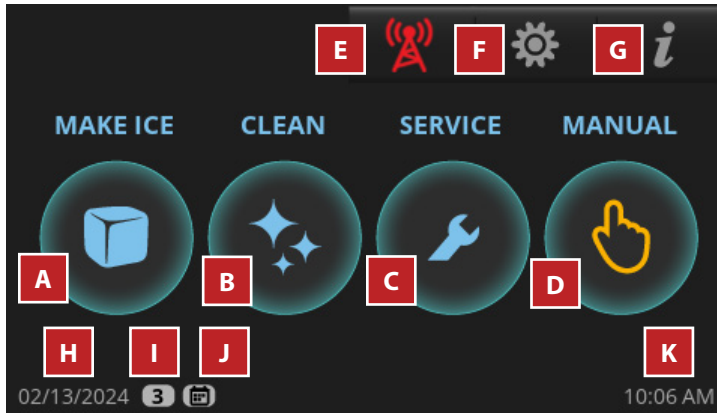

Manual Screen

Allows for manual operation of the four modes pictured.

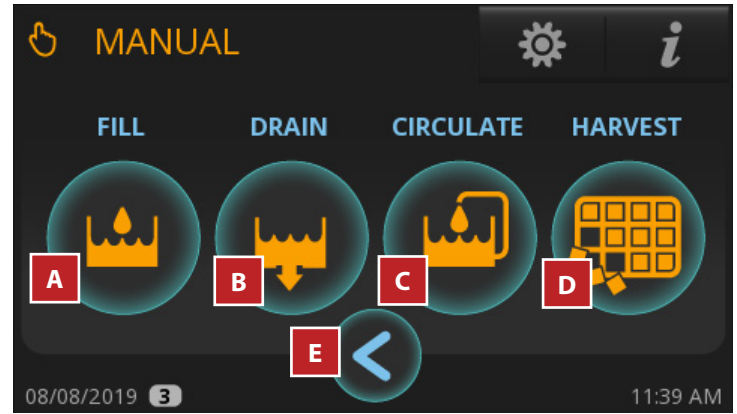

Parts of the MAIN Screen

A	Make Ice: Starts the Ice Making Sequence
B	Clean: Starts the Cleaning Sequence
C	Preventative Maintenance Timers: Opens "Counters" Screen
D	Manual Options: Opens "Manual" Screen
E	Remote Monitoring: Displays Remote Monitoring QR Code
F	Menu: Opens "Menu" Screen
G	Info: Opens "Real Time" Screen
H	Current date
I	Indicates Setting Access Level. See Function Access Levels (pg. 42)
J	Scheduling is enabled; See "Schedule Operation" (pg. 53)
K	Current time

Parts of the MANUAL Screen

A	Fill: Allows for Manual Fill of Sump
B	Drain: Allows for Manual Drain of Sump
C	Circulate: Allows for Manual Water Circulation
D	Harvest: Allows for Manual Harvest
E	Back: Goes Back to Previous Screen

About Your Ice Machine & Installation Requirements (cont.)

Plan Views

TCIM-422/522

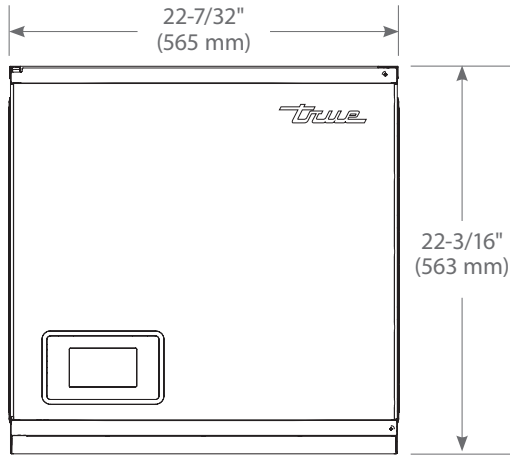

FRONT

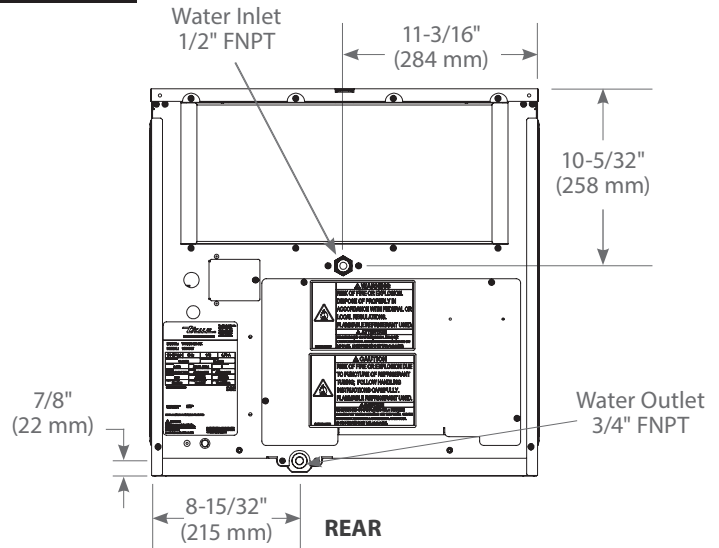

REAR

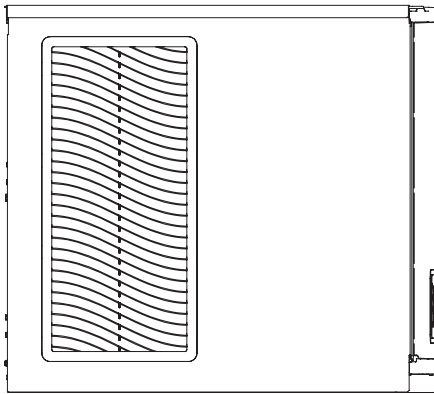

LEFT

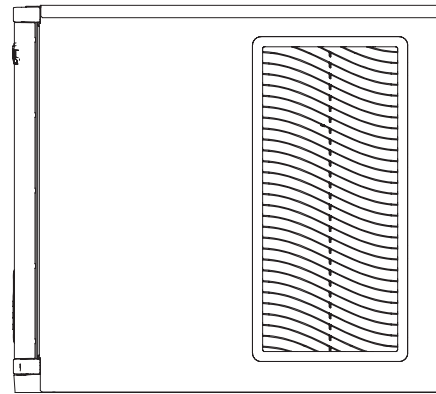

RIGHT

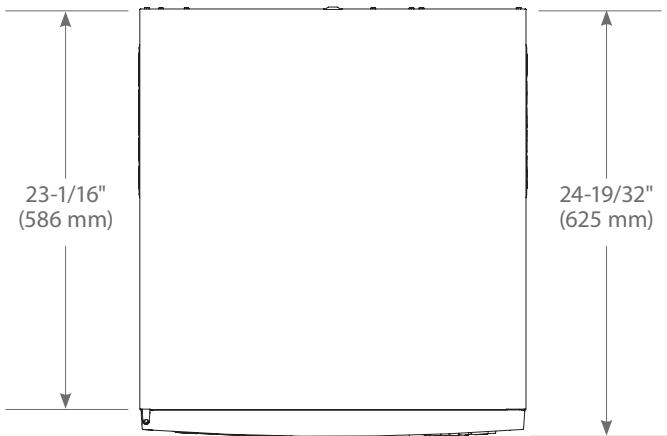

TOP

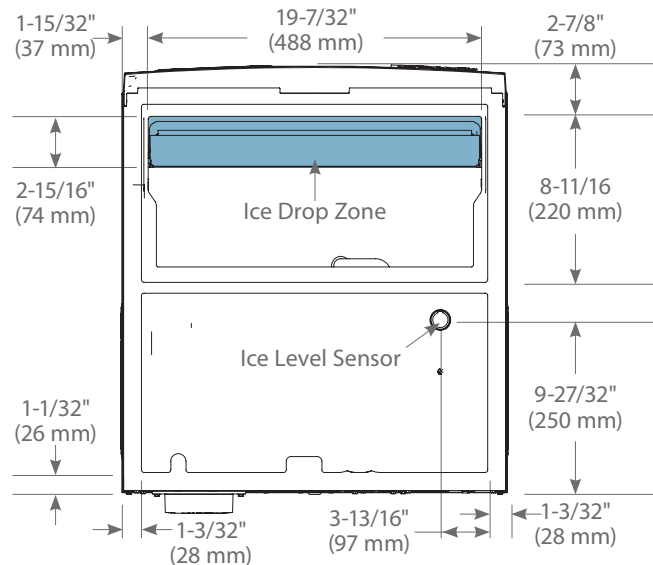

BOTTOM

Dimensions may vary by ± 1/8" (3.2 mm)

About Your Ice Machine & Installation Requirements (cont.)

Plan Views (cont.)

TCIM-430/530/630

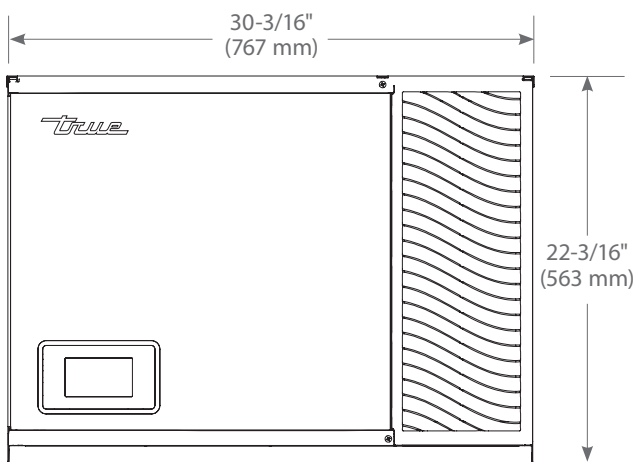

FRONT

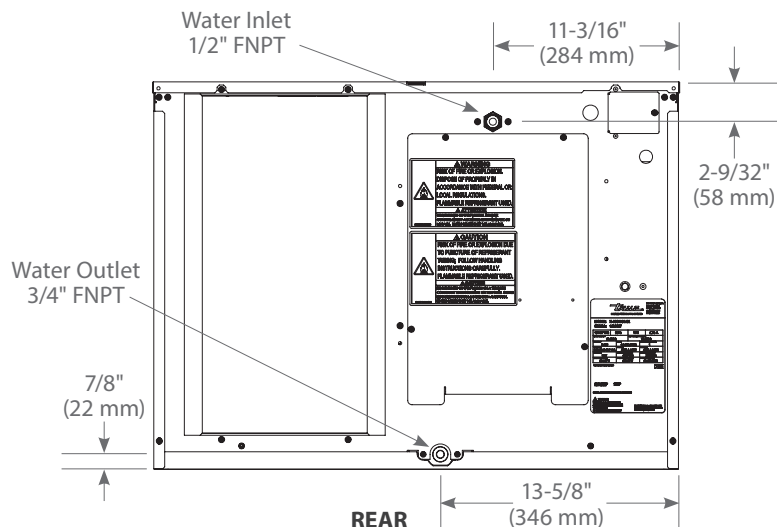

REAR

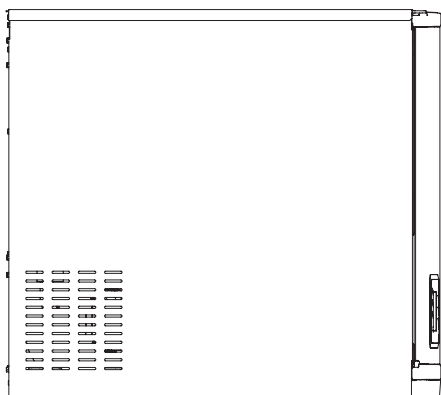

LEFT

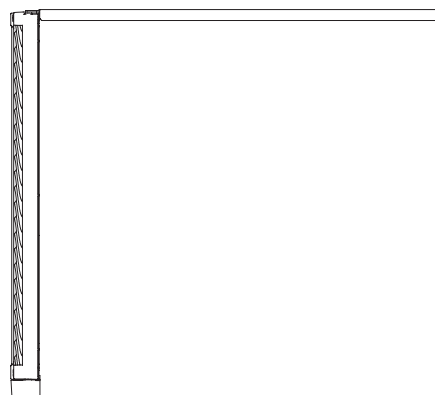

RIGHT

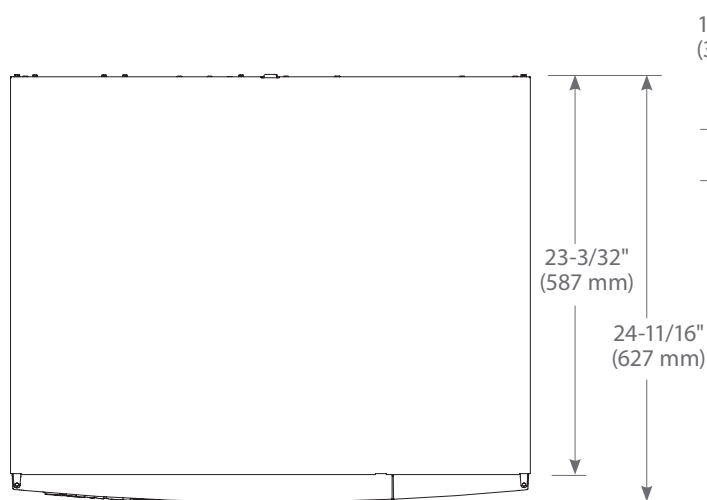

TOP

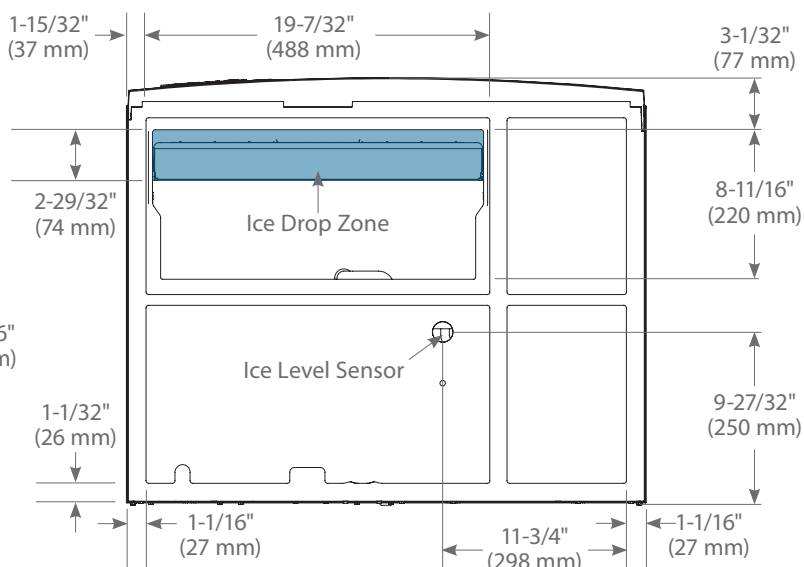

BOTTOM

Dimensions may vary by ± 1/8" (3.2 mm)

About Your Ice Machine & Installation Requirements (cont.)

Plan Views (cont.)

TCIM-622

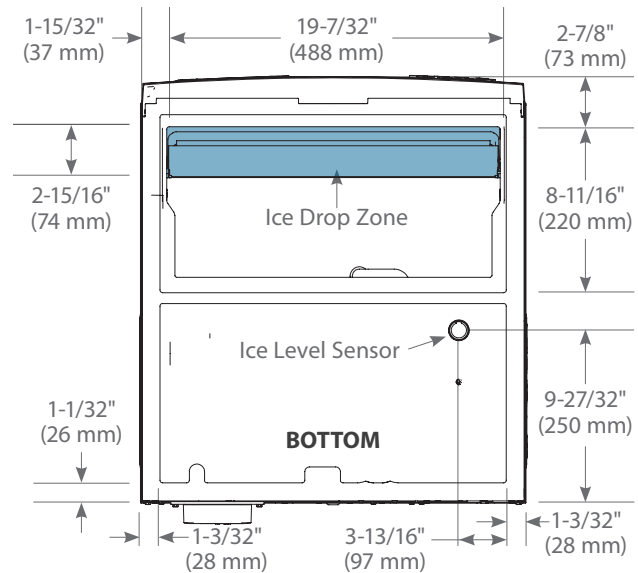
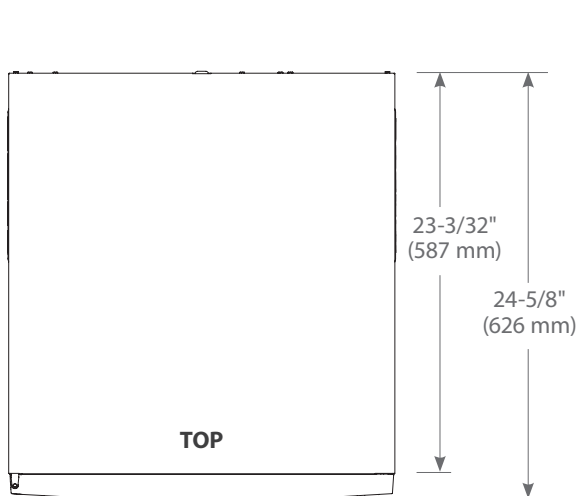
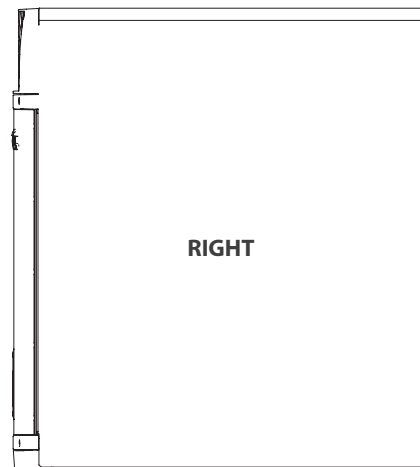
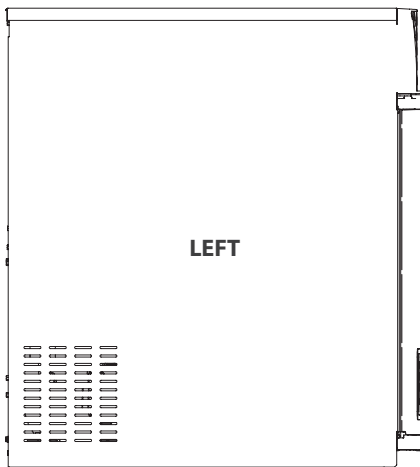
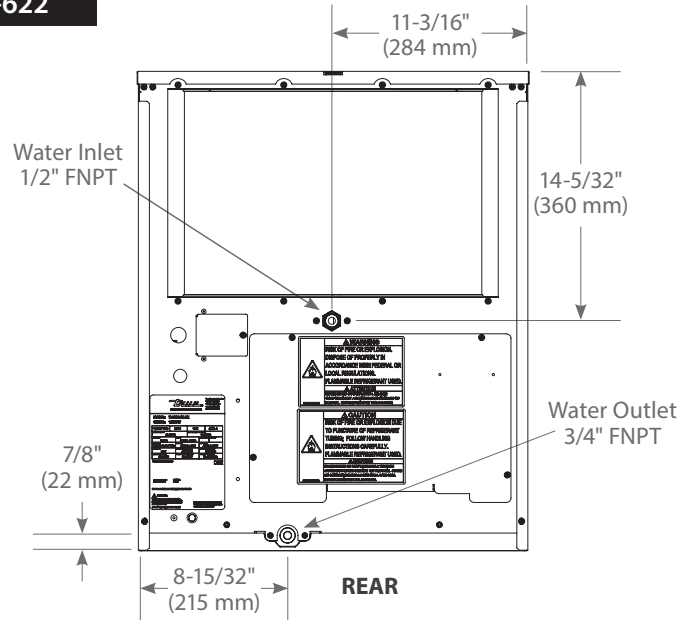
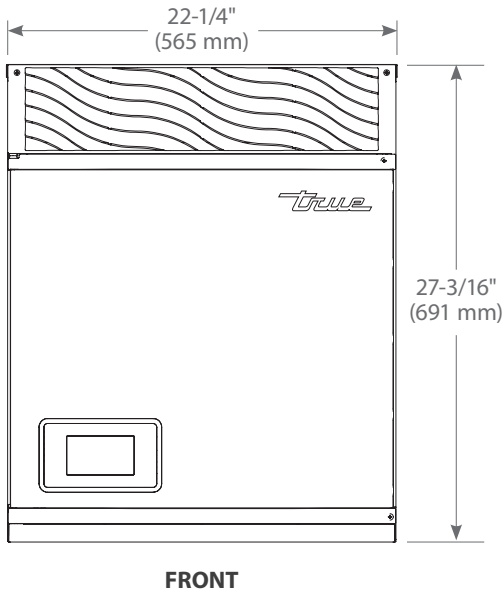

Dimensions may vary by ± 1/8" (3.2 mm)

About Your Ice Machine & Installation Requirements (cont.)

Plan Views (cont.)

TCIM-822

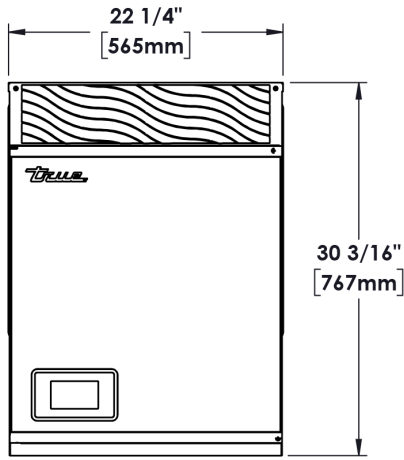

FRONT

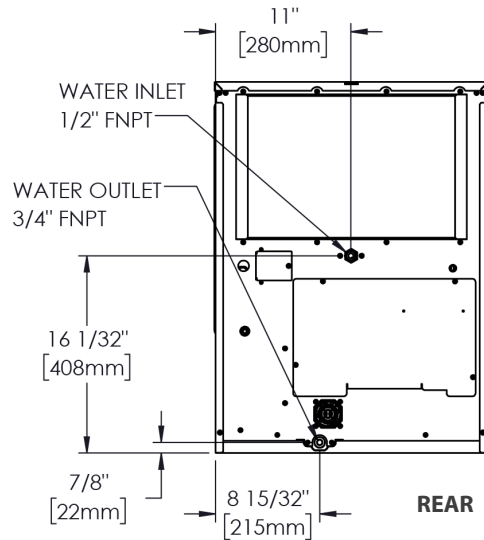

REAR

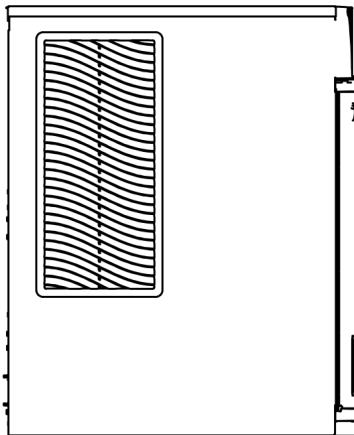

LEFT

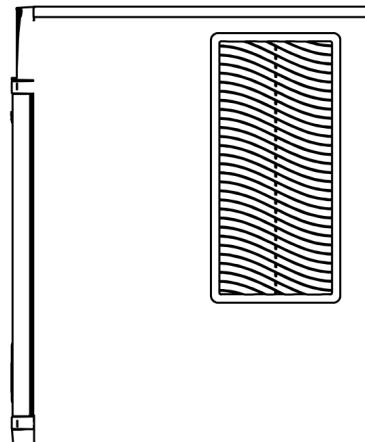

RIGHT

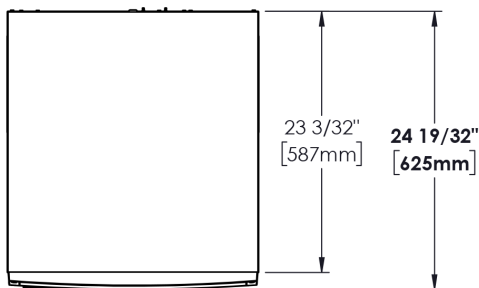

TOP

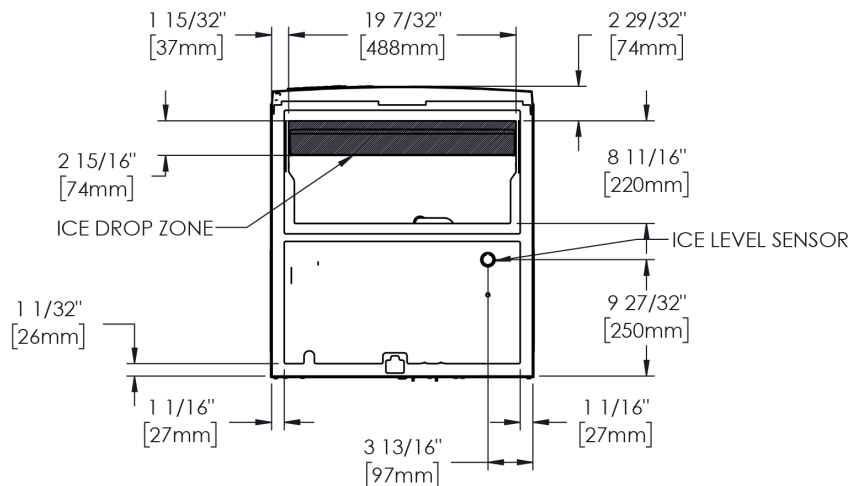

BOTTOM

Dimensions may vary by ± 1/8" (3.2 mm)

About Your Ice Machine & Installation Requirements (cont.)

Plan Views (cont.)

TCIM-830

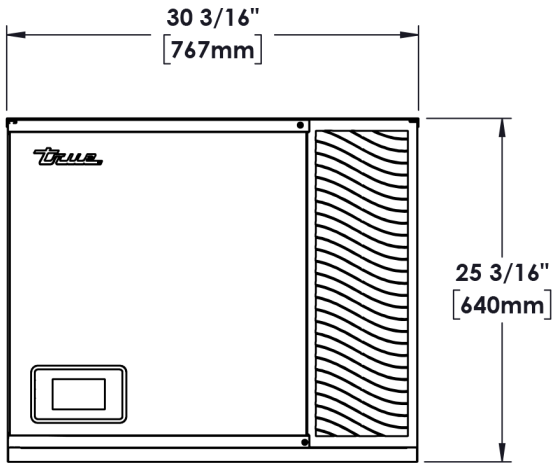

FRONT

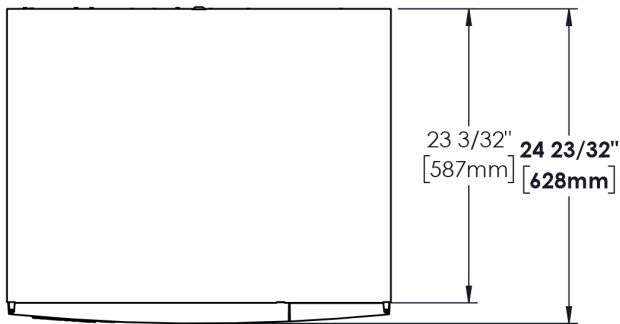
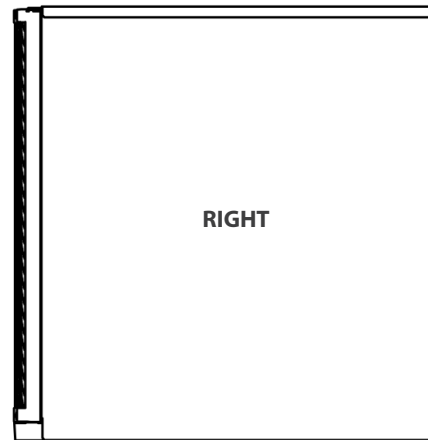
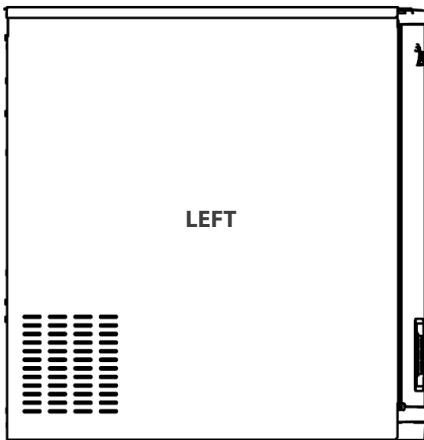
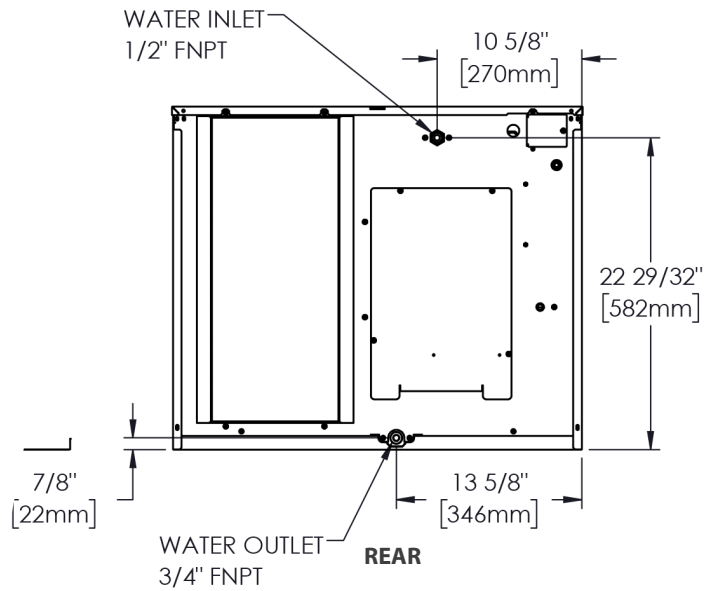

TOP

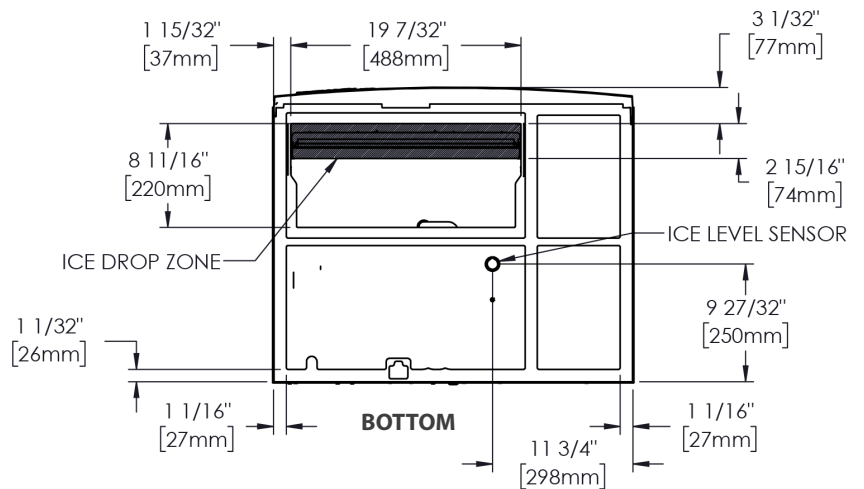

Dimensions may vary by ± 1/8" (3.2 mm)

About Your Ice Machine & Installation Requirements (cont.)

Plumbing Connection Requirements

⚠ WARNING!	
	Only connect your ice machine to a potable water supply.

ⓘ USER ACTION!	
	<p>DO NOT connect the ice machine to a hot water supply. Insulate the water line from sources of heat for greater operating efficiency. Supply water temperatures higher than the recommended maximum will cause reduced capacities.</p>
	<p>Inlet air gap included; no back-flow device required for the potable water inlet. This UL listed model has greater than a 1" (25.4 mm) anti-back flow air gap between the water inlet tube end and the highest possible sump water level. For further information, please see ul.com/database.</p>
	<p>Water Filters Recommended! True recommends water filters for all ice machines. Water filters help remove particulate that reduces operating efficiency and equipment life. Regularly changing water filters is essential for optimum-quality ice, reduced maintenance, and prolonged equipment operation.</p>
	<p>DO NOT ALLOW THE ICE MACHINE TO BE EXPOSED TO TEMPERATURES BELOW 32°F (0°C) WITHOUT WINTERIZING THE UNIT AS THIS WILL CAUSE ANY WATER IN THE MACHINE TO FREEZE. FAILURES CAUSED BY EXPOSURE TO FREEZING TEMPERATURES ARE NOT COVERED BY THE WARRANTY. See "Removal From Service & Winterization" (pg. 59).</p>

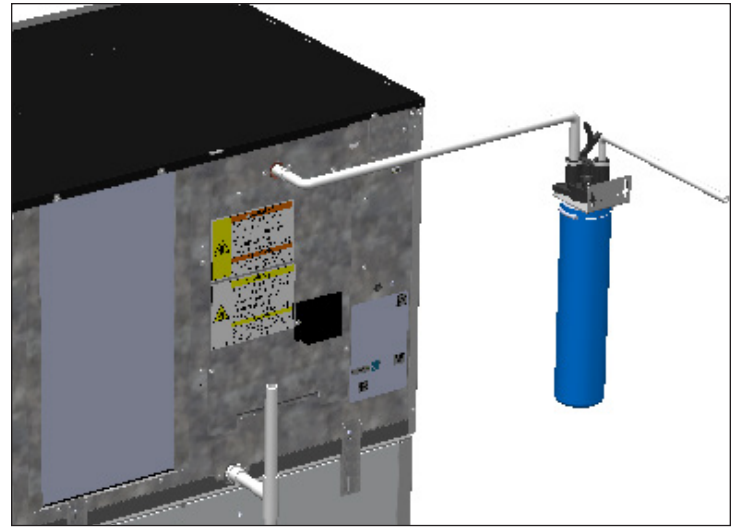

Fig. 1. Top plumbing connection example. Your application may differ.

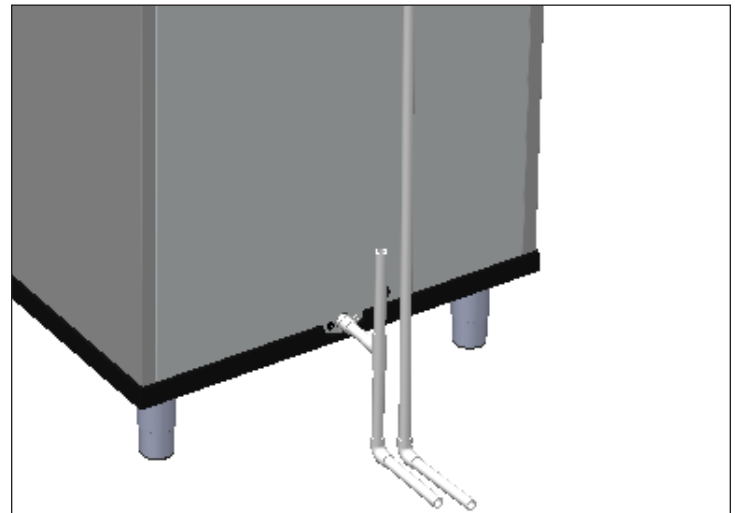



Fig. 2. Bottom plumbing connection example. Your application may differ.

ⓘ NOTICE!	
	Warranty does not cover issues caused by improper installation, lack of basic preventative maintenance, or harm caused to the ice machine by improper use of cleaners/sanitizers or by use of reverse osmosis water that does not have a neutral pH.

About Your Ice Machine & Installation Requirements (cont.)

Plumbing Connection Requirements (cont.)

Water Temperature & Pressure		
	Minimum	Maximum
Air Temperature	35°F (1.7°C)	110°F (43.3°C)
Water Temperature	35°F (1.7°C)	110°F (43.3°C)
Water Pressure	20 psig (138 kPa)	100 psig (689 kPa)

Plumbing Connections	
Water Supply	1/2" Female NPT Fitting
Drain Connection	3/4" Female NPT Fitting

Plumbing Connection Diagrams

Ice machine rear views shown.

TCIM-422/522

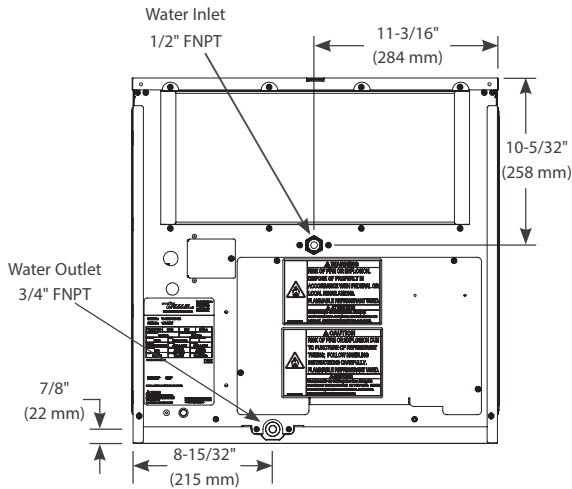

TCIM-622

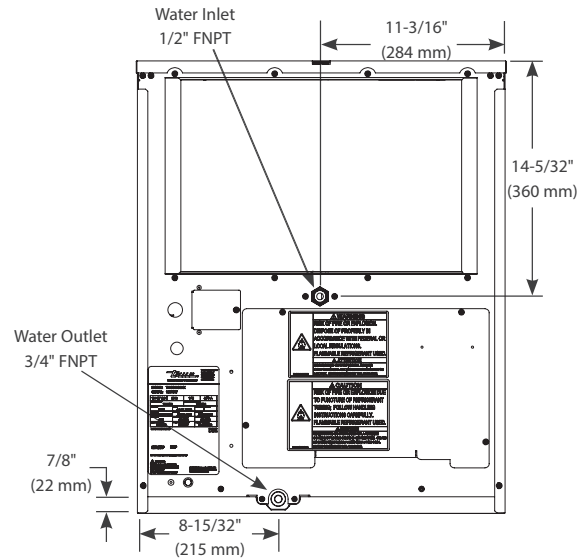

TCIM-430/530/630

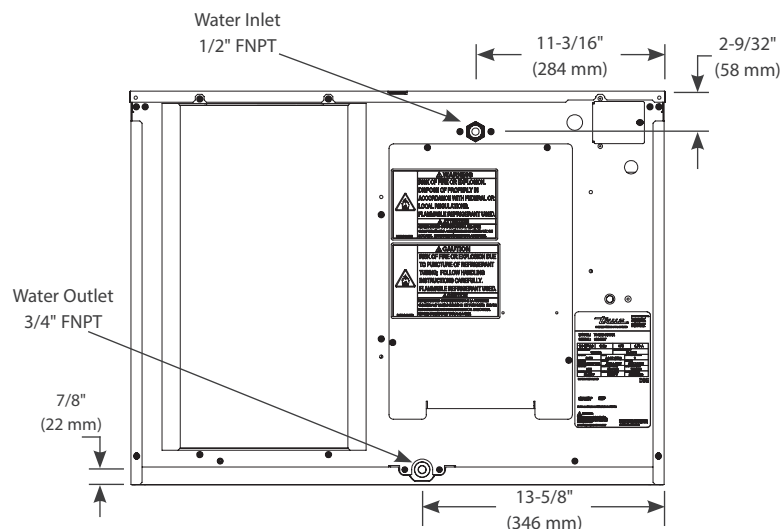

About Your Ice Machine & Installation Requirements (cont.)

Plumbing Connection Diagrams (cont.)

Ice machine rear views shown.

TCIM-822

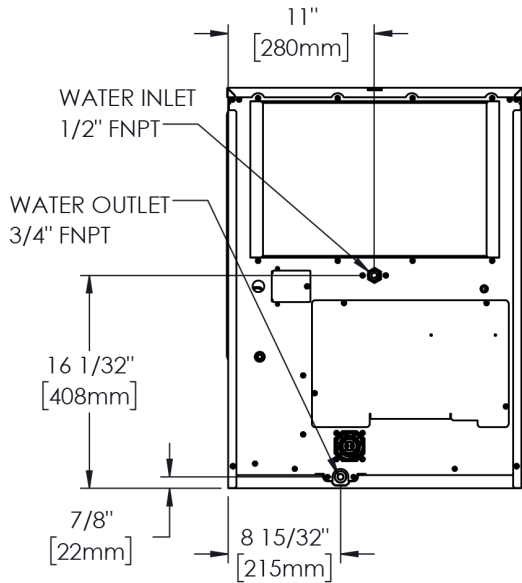

Drain Requirements

- Run the ice machine drain line, dispenser unit/ice storage bin drain line, and water-cooled condenser drain line (if applicable) separately.
- For optimum flow, drain lines must have 1/4" fall per 12" (20 mm fall per 1 m) of horizontal run.
- For correct drain flow, install a vented tee connection.
- Vent the sump drain. A vertical vent at the back of the drain, extended approximately 8-10" (203-254 mm) will allow the gravity drain to empty and keep any surges during draining from discharging water out the vent.
- DO NOT directly pipe drain lines to the sewer system. Keep a vertical air gap [2" (50.8 mm) minimum] between the drain line ends from the ice machine and condensation drain, dispenser unit/ice storage bin, and water-cooled condenser (if applicable) and the floor drain.
- Insulate drain tubing in humid environments.

TCIM-830

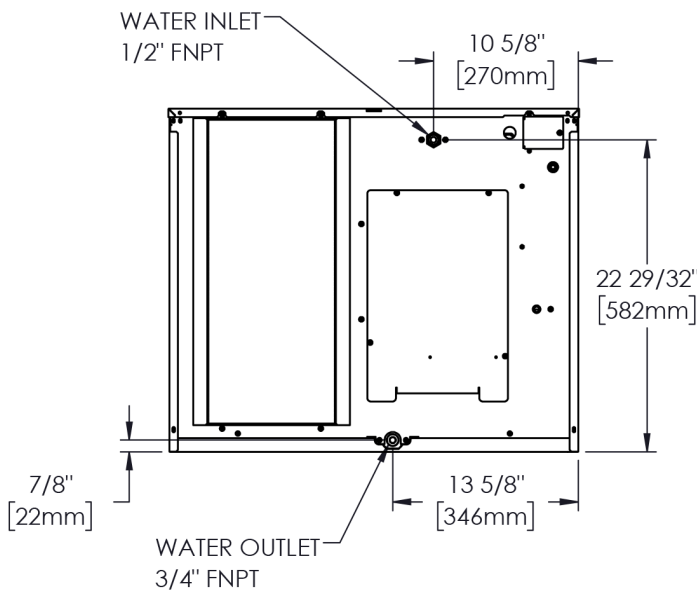

About Your Ice Machine & Installation Requirements (cont.)

Water Filter Setup

True recommends water filters for all ice machines. Water filters help remove particulate that reduces operating efficiency and equipment life. Regularly changing water filters is essential for optimum-quality ice, reduced maintenance, and prolonged equipment operation.

To setup your water filter, see the following instructions.

1. In the upper right corner of the screen, press **MENU**

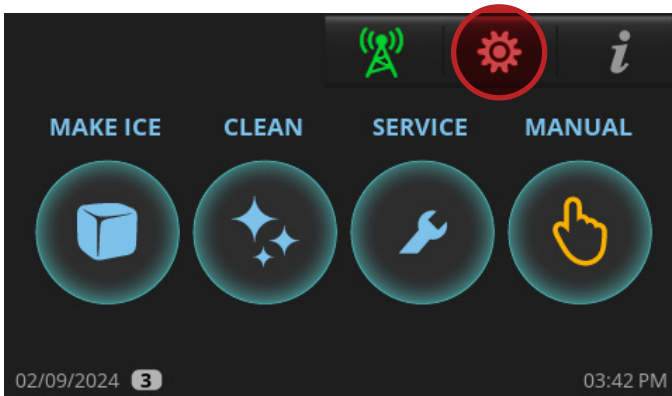

2. In the **MENU** screen, press **Water Filter**.



3. In the **Water Filter** screen, select the appropriate water filter for your application. True offers Standard and Platinum water filtration systems. If using a non-TRUE water filter, enter the water capacity under **CUSTOM**. See filter capacities in the water filter capacities table.



Filter Type	Capacity
Standard	14,000 gal (52,996 L)
Platinum	35,000 gal (132,490 L)
Custom (default)	10,000 gal (3,7854 L; adjustable)

About Your Ice Machine & Installation Requirements (cont.)

Electrical Requirements

⚠ **WARNING!**



Risk of Electric Shock, Burn, or Fire!

- Electrical connection must be hard-wired and meet all applicable laws, codes, and regulations. Failure to meet these code
- Requirements can result in appliance damage, fire, electrical shock, serious injury, or death.
- Your ice machine requires an independent power supply of proper capacity. See nameplate and rating labels for specifications "(see "Label Locations" (pg. 15))". Failure to use an independent power supply of proper capacity can lead to electrical fire.
- For personal safety, your ice machine must be properly grounded.

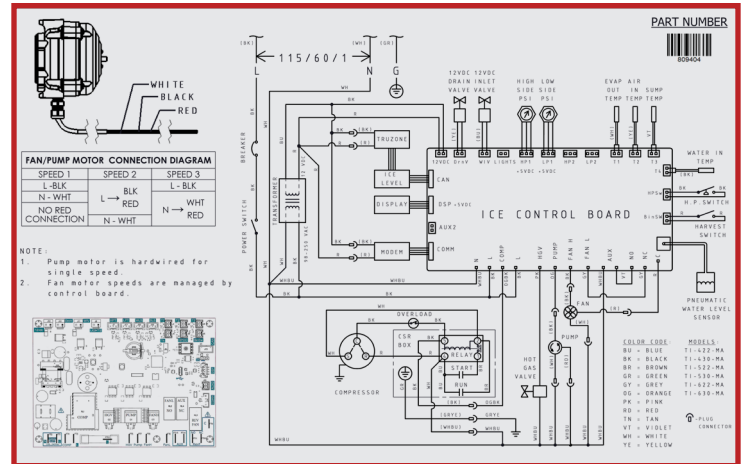

Fig. 1. Wiring diagram located under the top panel.

See "Cord Specifications" (pg. 29) for detailed electrical specifications. Electrical service must fall within the voltage tolerances listed.

- See wiring diagram beneath the top panel as shown in fig. 1. To access, see "Panel Removal" (pg. 31).
- Ice machines come equipped with a rocker switch. See location in fig. 2.
- Make electrical connections inside the ice machine's junction box on the appliance's rear. See figs. 3 and 4.

About Your Ice Machine & Installation Requirements (cont.)

Electrical Requirements (cont.)

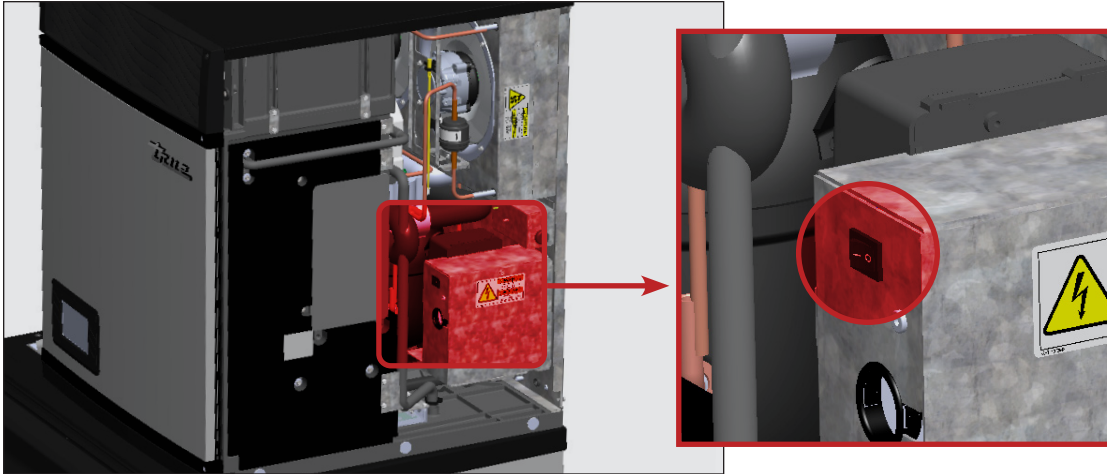

Fig. 2. Rocker switch location. Rocker switch disconnects power from the control board and front display; it DOES NOT disconnect power from the entire unit.

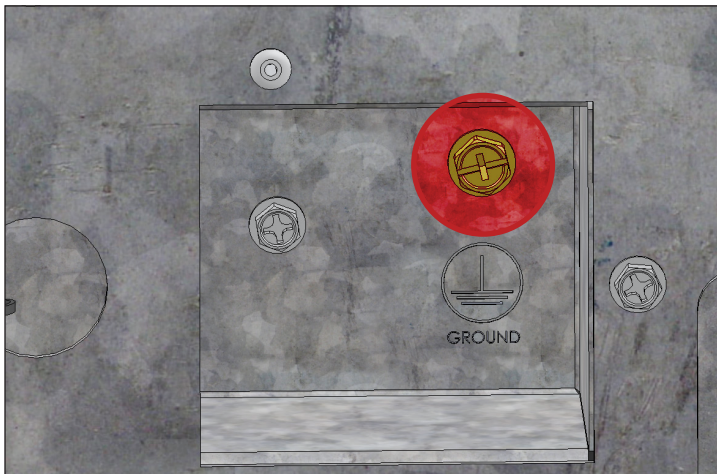
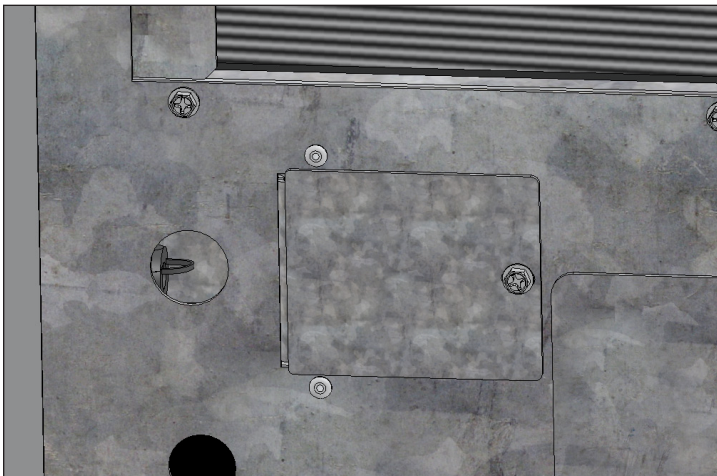
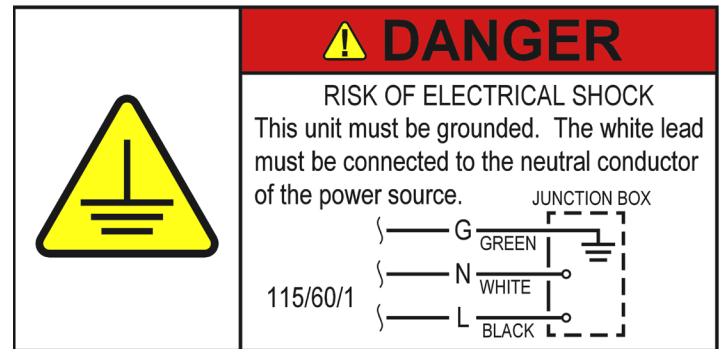
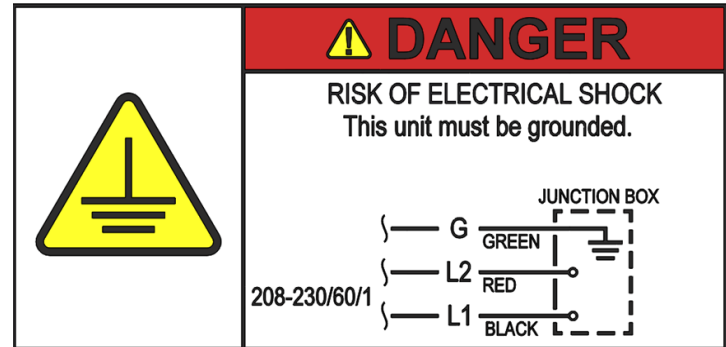

Fig. 3. Make the electrical connections inside the ice machine's junction box. Be sure to use strain reliefs. Always use the green grounding screw when making electrical connections.



225353



873390

Fig. 4. Junction box electrical label.

About Your Ice Machine & Installation Requirements (cont.)

Electrical Requirements (cont.)

Wire gauge chart (115V)												
115 Volts	Distance in Feet to Center of Load											
AMPS	20	30	40	50	60	70	80	90	100	120	140	160
2	14	14	14	14	14	14	14	14	14	14	14	14
3	14	14	14	14	14	14	14	14	14	14	14	12
4	14	14	14	14	14	14	14	14	14	12	12	12
5	14	14	14	14	14	14	14	12	12	12	10	10
6	14	14	14	14	14	14	12	12	12	10	10	10
7	14	14	14	14	14	12	12	12	10	10	10	8
8	14	14	14	14	12	12	12	10	10	10	8	8
9	14	14	14	12	12	12	10	10	10	8	8	8
10	14	14	14	12	12	10	10	10	10	8	8	8
12	14	14	12	12	10	10	10	8	8	8	8	6
14	12	12	12	10	10	10	8	8	8	6	6	6
16	12	12	12	10	10	8	8	8	8	6	6	6
18	12	12	10	10	8	8	8	8	8	8	8	5
20	12	12	10	10	8	8	8	6	6	6	5	5
25	10	10	10	8	8	6	6	6	6	5	4	4
30	10	10	8	8	6	6	6	6	5	4	4	3

Wire gauge chart (230V)												
230 Volts	Distance in Feet to Center of Load											
AMPS	20	30	40	50	60	70	80	90	100	120	140	160
5	14	14	14	14	14	14	14	14	14	14	14	14
6	14	14	14	14	14	14	14	14	14	14	14	12
7	14	14	14	14	14	14	14	14	14	14	12	12
8	14	14	14	14	14	14	14	14	14	12	12	12
9	14	14	14	14	14	14	14	14	12	12	12	10
10	14	14	14	14	14	14	14	12	12	12	10	10
12	14	14	14	14	14	14	12	12	12	10	10	10
14	12	12	12	12	12	12	12	12	10	10	10	8
16	12	12	12	12	12	12	12	10	10	10	8	8
18	12	12	12	12	12	12	10	10	10	8	8	8
20	12	12	12	12	10	10	10	10	10	8	8	8
25	10	10	10	10	10	10	10	10	8	8	6	6
30	10	10	10	10	10	10	8	8	8	6	6	6

Cord Specifications

The opening for the power supply connection is 7/8" diameter to fit a 1/2" trade size conduit.

Min/Max Circuit Ampacity & Fuse Size			
Model	Minimum Circuit Ampacity	Maximum Overload Protection	Breaker/ Fuse Size
TCIM-422	15 Amps	15 Amps	15 Amps
TCIM-430	15 Amps	15 Amps	15 Amps
TCIM-522	15 Amps	15 Amps	15 Amps
TCIM-530	15 Amps	15 Amps	15 Amps
TCIM-622	15 Amps	20 Amps	15 Amps
TCIM-630	15 Amps	20 Amps	15 Amps
TCIM-822	15 Amps	20 Amps	15 Amps
TCIM-830	15 Amps	20 Amps	15 Amps

Min/Max Voltage Supply		
Nominal Voltage	Minimum No Load	Maximum No Load
115 Volts	104 Volts	127 Volts
230 Volts	208 Volts	254 Volts

Installation & Setup

Installation & Setup

⚠ WARNING!	
 	<p>The appliance owner is responsible for performing a Personal Protective Equipment (PPE) Hazard Assessment and ensuring adequate protection during maintenance and cleaning procedures. Use appropriate tools, safety equipment, and PPE during installation and servicing.</p>
	<p>Tip over hazard!</p> <ul style="list-style-type: none"> Ice machine may pose a tipping hazard when uncrating, installing, or moving the appliance. Take appropriate safety precautions. At least two people are required to lift or move the ice machine to prevent tipping or personal injury. Use of tip over restraints may only reduce (not eliminate) the tipping hazard. Never allow children to climb or hang on drawers, doors, or shelves.
	<p>Sharp Edges!</p> <ul style="list-style-type: none"> Take care when moving, installing, cleaning, servicing, and maintaining the ice machine to avoid cuts. Be sure to take care when reaching under the ice machine or handling metal components.

Ice Machine Location

- Failure to install, operate, and maintain the ice machine in accordance with this manual will adversely affect safety, performance, component life, and warranty coverage and may result in costly water damage.
- The location must allow enough clearance for water, drain, and electrical connections in the rear of the ice machine.
- The location must not obstruct airflow through or around the ice machine.
- Always install equipment on a stable and level surface.
- The equipment must be level side-to-side and front-to-back.
- To avoid instability the installation area must be capable of supporting the combined weight of the equipment and product.

Uncrating

1. Inspect the exterior packaging for damage. Follow True's recommended procedure for accepting deliveries.

NOTICE > If your ice machine is damaged, note all damage on the delivery receipt, immediately file a claim with the delivery freight carrier, and contact True.
2. Remove the exterior packaging. Inspect your ice machine for visible or cosmetic damage.

NOTICE > If your ice machine is damaged, note all damage on the delivery receipt, immediately file a claim with the delivery freight carrier, and contact True.
3. Move your ice machine as close to the final installation location as possible before removing the wooden skid.

Installation & Setup (cont.)

Panel Removal

1. Remove the front panel screws. Then, open the front panels. See fig. 1.

NOTICE > Panels cannot be removed without opening the front panels.

2. Carefully lift the front of the top panel. Then, slide the top panel towards the ice machine's rear and lift the panel. See fig. 2.
3. Remove the side panel's rear screw. See fig. 3.
4. Unfasten the side panel's bottom fasteners. Then, lift the side panel. See fig. 4.

Interior Inspection

1. Remove the shipping tape and packing material. If any are left in the ice machine it will not work properly.
2. Inspect the interior for damaged components.
3. Check that the refrigerant lines do not rub or touch each other or other surfaces, and that the fan blade turns freely.
4. Check that the compressor is snug on all mounting pads.
5. Position the dispenser unit/ice storage bin in its permanent location.



Fig. 1. Front panel screw locations.

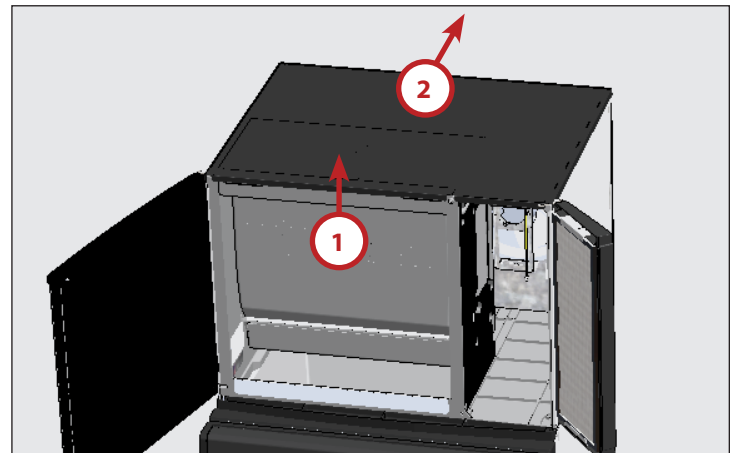

Fig. 2. Lift the front edge, slide the top panel back, then lift to remove.

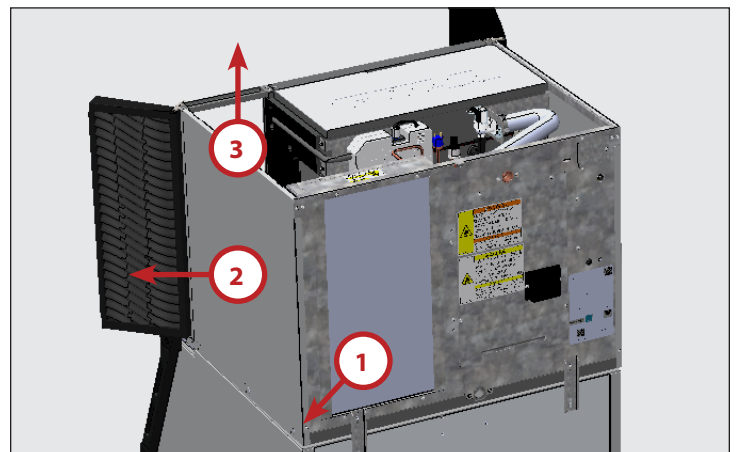



Fig. 3. Remove the screw, pull panel from adhering tabs, then lift to remove.

Installation & Setup (cont.)

Ice Storage Bin or Dispenser

⚠ WARNING!



Tipping hazard! ALWAYS verify center leveling screws fully contact the floor after leveling the appliance.

ⓘ NOTICE!



Installer must ensure the dispenser unit/ice storage bin is compatible with the ice machine, and the dispenser unit/ice storage bin and ice machine are properly attached and secured. See fig. 1. Before mounting the ice bin, always measure for the ice level sensor. See "Ice Level Sensor Setup" (pg. 36).

- The ice machine can be installed on a dispenser unit or ice storage bin. If required, install an adapter kit or top kit. See fig. 3. Contact True for recommendations.
- Ice machines require a deflector when installed on an ice storage bin. Before using a non-OEM ice storage system with this ice machine, contact the bin manufacturer to assure their ice deflector is compatible.
- Before installing a non-OEM ice storage system with this ice machine, follow the manufacturer's installation procedures and verify the location and installation meets the local/national mechanical codes and stability requirements.
- Follow the ice storage bin, adapter kit, or top kit instructions for securing the ice machine. If no instructions are available, secure the ice machine using the provided mounting brackets and bolts.
- If mounting the ice machine on top of a dispenser unit, follow the dispenser unit's setup procedure. If mounting the ice machine on top of an ice storage bin, unpack the ice storage bin and attach the provided adjustable legs to the bottom of the ice storage bin.
- Adjust the legs to level the dispenser unit/ice storage bin both left-to-right and front-to-rear. Place the ice machine on top of the dispenser unit/ice storage bin.
- See plan views for drop-zone specifications. Be sure the location of the drop-zone is compatible with your ice storage compartment. Verify the ice will fall freely and not catch on parts of the ice storage.
- Drop-zone deflectors allow ice to fall farther back into the ice storage to clear any obstruction. See figs. 4 and 5. Contact True Parts Department at truemfg.com/parts.

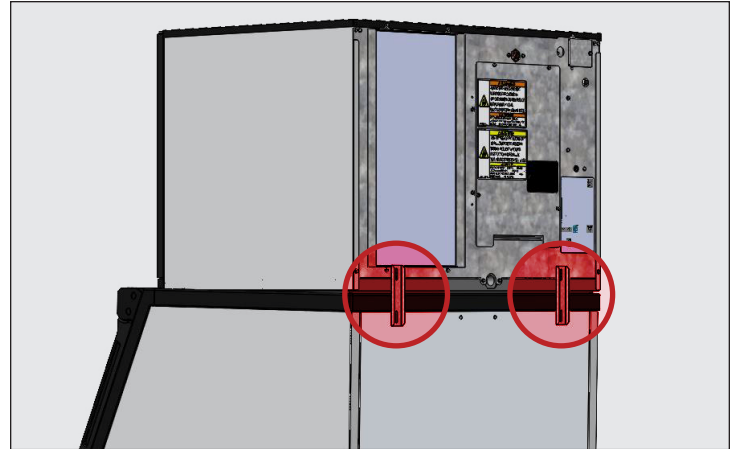

Fig. 1. Installed bin brackets.



Fig. 2. Always measure the bin (A) or dispenser (B) for the ice level sensor before mounting the ice machine.

Installation & Setup (cont.)

Ice Storage Bin or Dispenser (cont.)

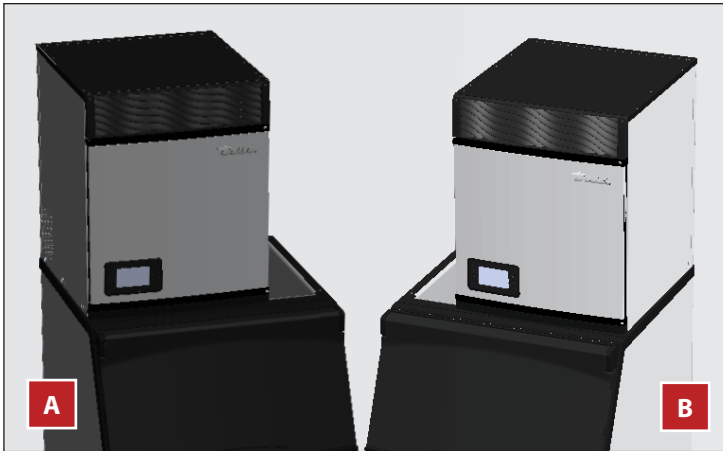

Fig. 3. A 22" ice machine mounted left (A) and right (B) on a 30" bin with a bin adapter.



Fig. 4. Installed drop-zone deflector side view.



Fig. 5. Ice bins with (A) and without (B) a drop-zone deflector.

Bin Adapters

Bin adapters cover the opening when the ice storage bin is wider than the ice machine. See examples of possible configurations below. To purchase, contact TRUE Parts Department at 800-424-8783 or partsinquiries@truemfg.com.

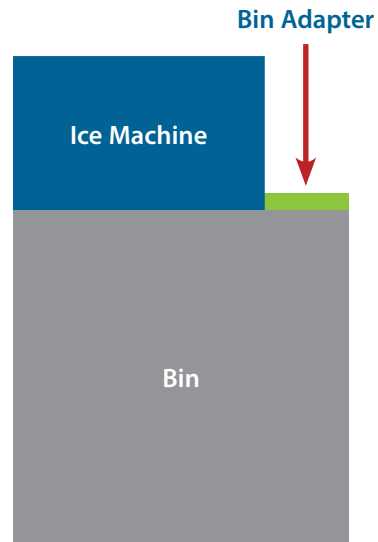

Fig. 1. Ice machine on one side of the bin.

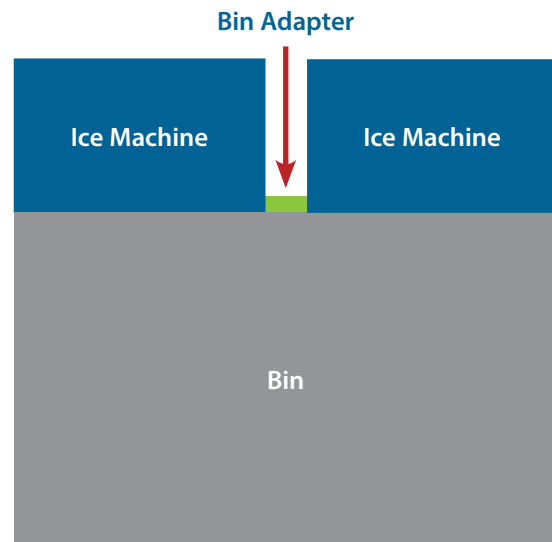

Fig. 2. Ice machines installed on both sides of the bin.

Leveling

Verify the ice machine is level front-to-back and side-to-side. Adjust level as needed.

Installation & Setup (cont.)

Antenna & Modem Installation (Optional Accessory)

1. Locate light grey modem harness on right side (22" Machine) or left side (30" Machine). Undo twist tie and feed connectors through bushing nearby on rear panel. See fig. 1.
2. Pull enough harness through the bushing to connect to the modem ports. See fig. 2.
3. Install the antenna onto the modem.

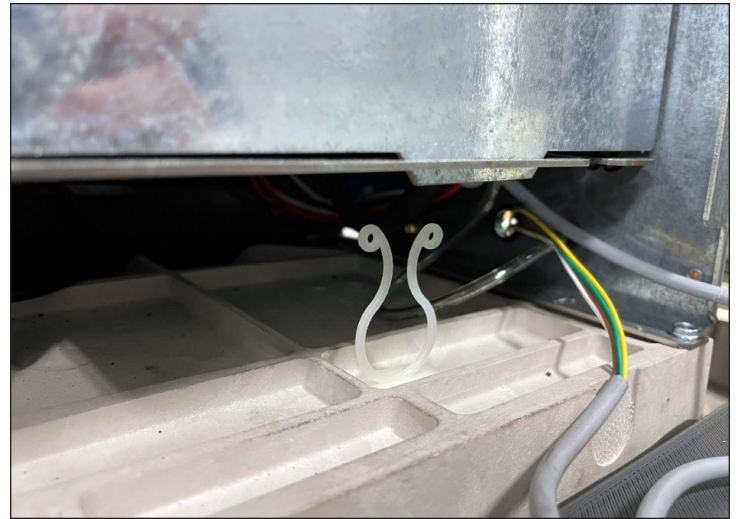

Fig. 1. Light grey modem harness.



Fig. 2. Wire harness connected to modem. Green/Yellow to TEC; Brown/White to POWER.

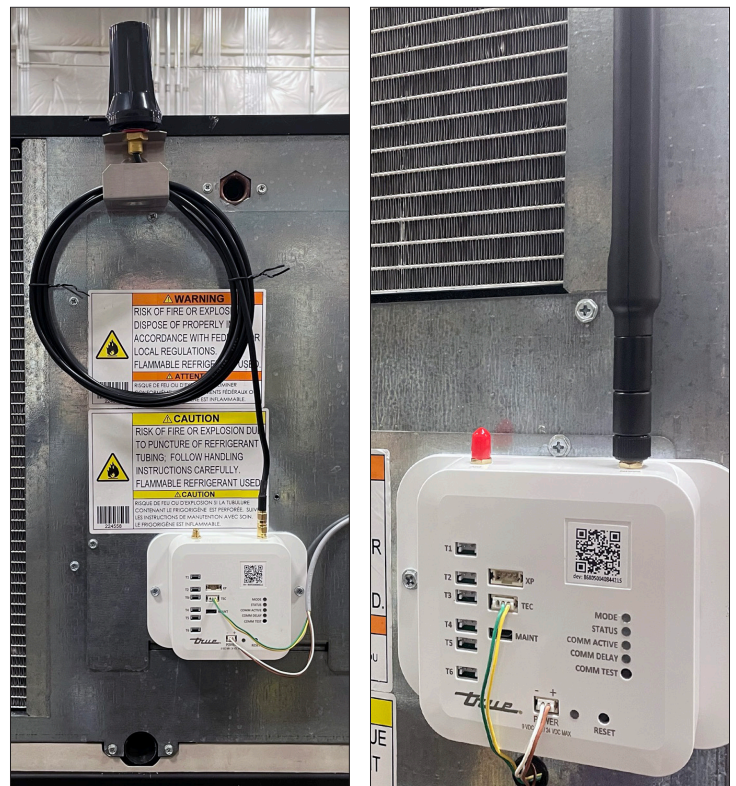



Fig. 3. Installed antenna on modem. Your antenna may vary.

Installation & Setup (cont.)

Remote Monitoring

Press Remote Monitoring  to access the Remote Monitoring QR Code. Follow instructions on the remote monitoring website. See fig. 1.

The color of the remote monitoring icon indicates the current status of the remote monitoring. See fig. 2.

For more information, visit connect.truemfg.com



Fig. 1. Remote monitoring screen displays.

Green: Connected

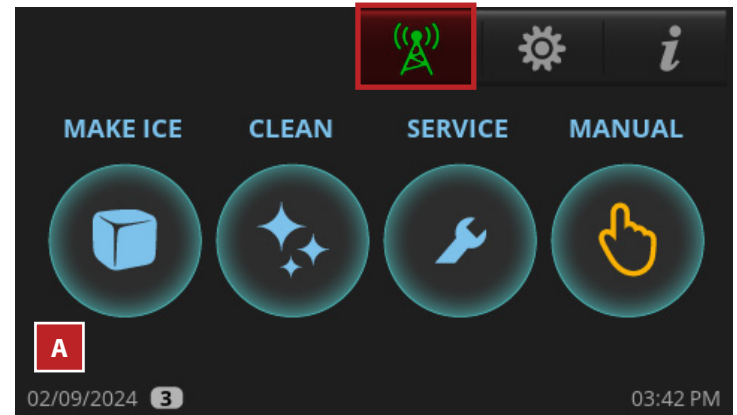

Red: No cell signal, no RS485, or no power

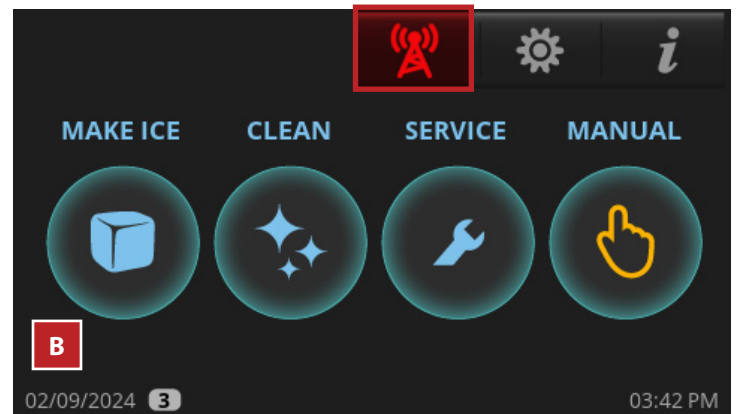

Fig. 2. The green icon (A) and the red icon (B).

Installation & Setup (cont.)

Dispenser Bracket

! USER ACTION!

!

Ice level management is recommended to prevent water leakage or movement of ice machine during agitation. See "Ice Level Sensor Setup" (pg. 36).

Follow the dispenser unit, adapter kit, or top kit instructions for securing the ice machine. If no instructions are available, secure the ice machine with the provided mounting brackets.

1. Rotate the mounting brackets so that they fit flush to the dispenser unit.
2. Secure the mounting brackets to the ice machine with the bolts provided.
3. Secure the mounting brackets to the dispenser unit with self-tapping screws (not provided).

NOTICE > Avoid damage to dispenser unit components when attaching the mounting brackets.

Ice Level Sensor Setup

The ice level sensor utilizes Time of Flight (TOF) technology to detect the amount of ice in the ice storage unit. The sensor has a safe Class 1 laser with no possibility of eye damage. This sensor can adjust the FULL BIN setting to any ice level the user desires. You must set up the ice level sensor for use with your ice storage unit. See the following instructions.

1. In the upper right corner of the screen, press Menu

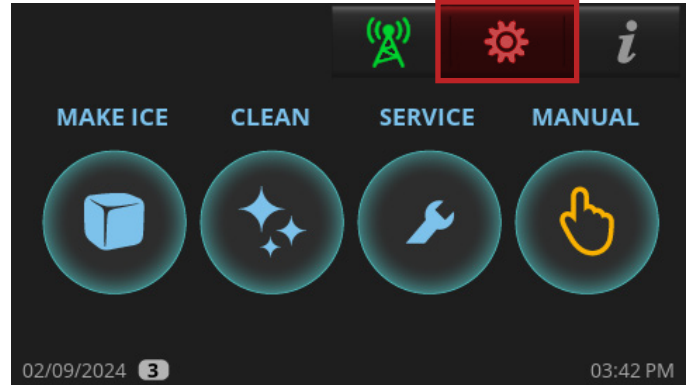

2. In the **Menu** screen, press **TOF**.



3. In the **Ice level sensor** screen, select the appropriate preset value for your ice storage unit. Select custom if no preset value meets your application needs. See preset values in the ice level sensor presets table.

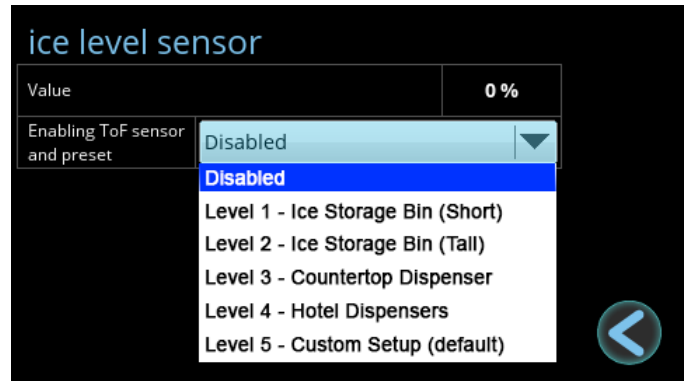

Installation & Setup (cont.)

Ice Level Sensor Setup (Cont.)

Ice Level Sensor Presets			
	Full Bin Distance (FBD)	Empty Bin Distance (EBD)	Full Bin Ice Threshold (PBD)
Level 1 – Ice Storage Bin (Short)	30 cm	85 cm	100
Level 2 – Ice Storage Bin (Tall)	20 cm	108 cm	100
Level 3 – Countertop Dispenser	25 cm	65 cm	90
Level 4 – Hotel Dispensers	25 cm	85 cm	90
Level 5 – Custom Setup	20 cm	120 cm	60

Custom Setup

Press the values to open the number pad. Enter the desired setting and press ok.

- Full Bin Distance (FBD) is the distance in centimeters between the sensor and the ice when the machine enters the FULL BIN state with the damper held down. See fig. 1.
- Empty Bin Distance (EBD) is the distance in centimeters between the sensor and the bottom of the ice storage unit. See fig. 1.

NOTICE TRUE recommends only adjusting EBD.

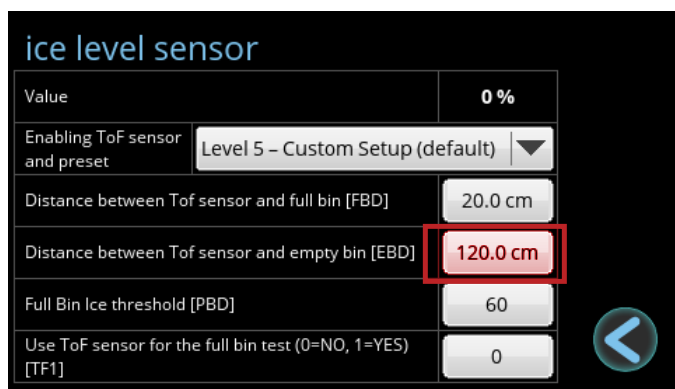

FULL BIN Control

The FULL BIN state is normally controlled by the harvest flap. However, the ice level sensor can be used to control the FULL BIN state of the machine by setting the value of TF1 equal to 1. This is typically used when an ice machine is installed on a dispenser and a lower ice level is required.

The machine will enter the FULL BIN state once the Value is greater than the Full Bin Ice Threshold [PBD].

For instance, if PBD is set to 50, then the ice machine will enter the FULL BIN state when the Value is greater than 50% (in other words, when the ice storage unit is at least half full).

The machine will still enter the FULL BIN state if the damper is held down.

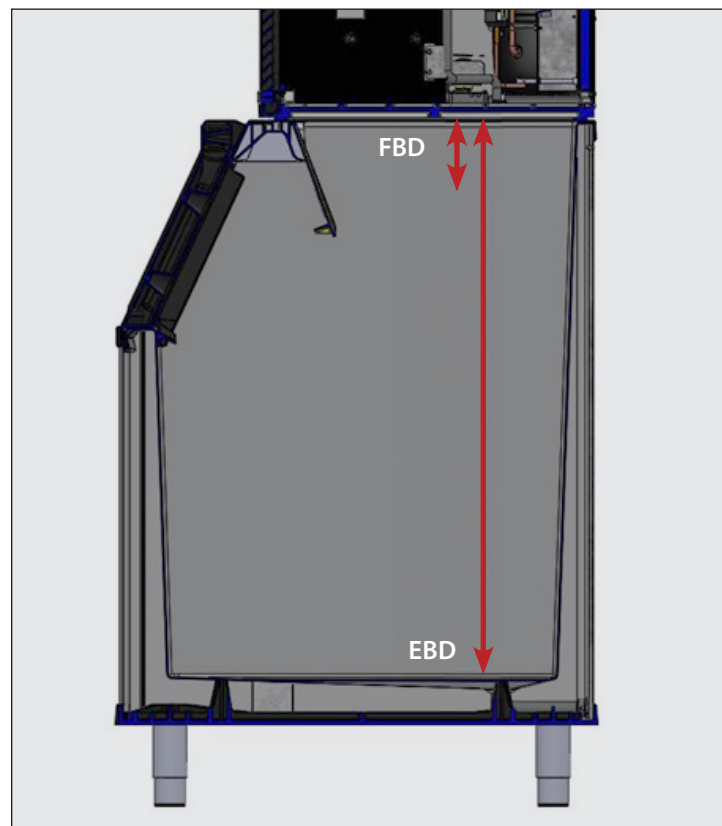







Fig. 1. FBD vs. EBD.

Installation & Setup (cont.)

Initial Sanitizing

Sanitize the ice machine before use. For sanitizing procedure, please see "Descaling and Sanitizing Procedure" (pg. 64).

⚠ DANGER!	
  	<p>HIGHLY CORROSIVE CLEANING CHEMICALS.</p> <p>Avoid contact with eyes and skin. Wear eye protection and chemical-resistant rubber gloves when handling.</p>

⚠ WARNING!	
	<p>Toxic Material Hazard!</p> <p>DO NOT MIX DESCALER WITH SANITIZER. Harmful fumes may be generated.</p>
	<p>Optical Radiation Hazard! UV Light!</p> <p>Invisible laser radiation. Do not look directly at light. Always disconnect power before servicing the lamp.</p>

! USER ACTION!	
	<p>True recommends using TRUE Ice Machine Descaler. To purchase, contact True Parts Department at 800-424-8783 or partsinquiries@truemfg.com.</p> <p>If using a non-TRUE descaler (Nickel-safe) recommended dilution for soaking parts is 3 fl oz (88.7 mL) per 1 gal (3.78 L) and recommended amount for evaporator cleaning is 6-8 fl oz (177.4-236.6 mL).</p> <p>Use of non-recommended descaler may void warranty.</p>

	⚠ CAUTION
	CLASS 1 LASER PRODUCT Invisible Laser Radiation When Opened. Disconnect Power Before Servicing
	⚠ ATTENTION
PRODUIT LASER DE CLASSE 1 Rayonnement Laser Invisible à l'ouverture. Couper l'alimentation avant entretien.	
PART # 819871	

Installation & Setup (cont.)

Installation & Setup Checklist

- Have you connected the modem wires and antenna as shown on pg. 34?
- Have you enabled the TOF sensor and set the ice storage bin as shown on pg. 36?
- Is the ice machine level?
- Is the ice machine located where the ambient temperature is within 35°-110°F (1.7°- 43.3°C) and the water temperature within 35°-110°F (1.7°-43.3°C) all year around?
- Does the ice machine have the proper clearance for air circulation and service? See "Ice Machine Specifications" (pg. 14).
- If present, are the air filter and blank cover installed on the correct side to meet clearance requirements?
- Have all shipping materials been removed from the ice machine's exterior and interior?
- Is the ice machine on a dedicated electrical circuit?
- Have all electrical and water connections been made?
- Do electrical and water connections meet applicable laws, codes, and regulations?
- Has the power supply voltage been checked or tested against the nameplate rating?
- Has a proper ground been installed to the ice machine?
- Are the water supply and drain lines sized as specified (pg. 23)?
- Are the shut-off valve(s) and drain valve(s) installed?
- Is the water supply pressure between 20-100 psig (138-689 kPa)?
- Is the compressor snug on all mounting pads?
- Have the refrigerant lines been checked to ensure they do not rub or touch other lines or surfaces?
- Has the fan blade (if applicable) been checked to ensure it turns freely?
- Has the end user been given the instruction manual, as well as instructed on how to operate the ice machine and the importance of the recommended periodic maintenance?
- Has the end user been given the contact information for an authorized service agent?
- Has ice machine and bin/dispenser been sanitized per the manufacturer's instructions?
- Is the drain line vented?

Ice Machine Operation

Control Display Modes & Operation

Set the Access Level

There are four access levels: USER (0), ADMIN (1), ADMIN (2), and ADMIN (3). The USER (0) level is designed with your customer in mind. It allows them to see the mode of operation and screen saver but restricts any function that would affect the ice machine. The ADMIN (1) level is for the ice machine owner. ADMIN (2) is for qualified service technicians and ADMIN (3) is restricted to the manufacturer.

Ice Machine Operation (cont.)

Function Access Levels				
Functions	Sub-Functions	USER (0)	ADMIN (1)	ADMIN (2)
MAKE ICE	Turning the ice machine ON or OFF		X	X
CLEAN			X	X
RCU	Reverse Condenser Fan		X	X
MANUAL	FILL		X	X
	DRAIN		X	X
	CIRCULATE		X	X
	HARVEST		X	X
MENU	Date, Hour, Language		X	X
	SCHEDULING		X	X
	Parameters			Limited
	Ice Thickness [BIG]		X	X
	Levels of water hardness or scale [SCA]		X	X
	Ice Level Sensor [TOF]			X
	Light (N/A)			
	UV info			X
	Water Filter			X
	Counters/Reminders			X
Information Screen	Temperature and Pressure Graph			X
	ACTIVE ALARMS			X
	ALARM LOG			X
	Statistics			X
Touching Screen to Hide Screen Saver		X	X	X
Touching Screen to Silence Alerts		X	X	X

Ice Machine Operation (cont.)

Basic Screen & Icon Definitions

Home Screen

The default display screen.

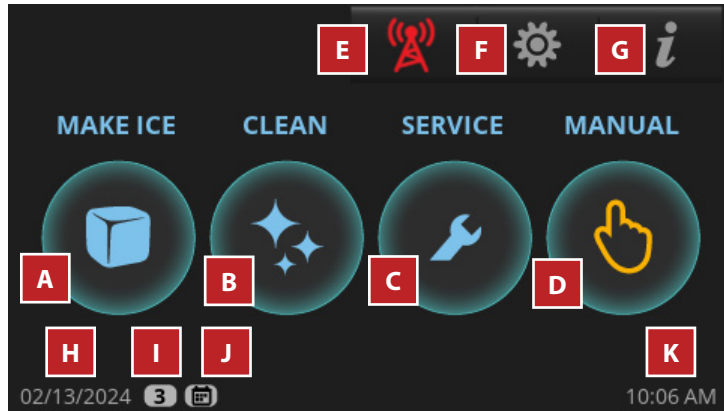

Manual Screen

Allows for manual operation of the four modes pictured.

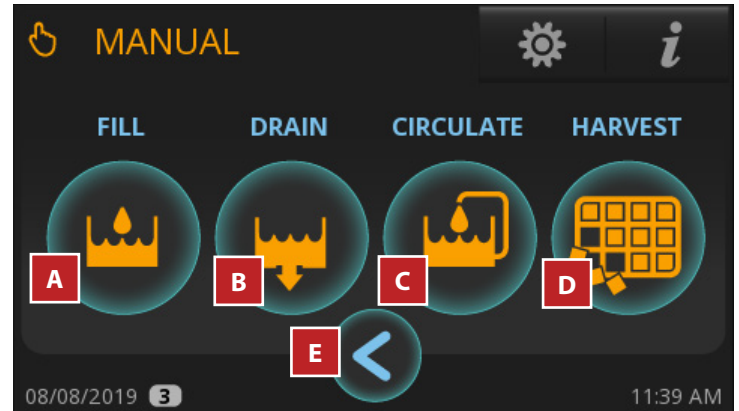

Parts of the MAIN Screen

A	Make Ice: Starts the Ice Making Sequence
B	Clean: Starts the Cleaning Sequence
C	Preventative Maintenance Timers: Opens "Counters" Screen
D	Manual Options: Opens "Manual" Screen
E	Remote Monitoring: Displays Remote Monitoring QR Code
F	Menu: Opens "Menu" Screen
G	Info: Opens "Real Time" Screen
H	Current date
I	Indicates Setting Access Level. See Function Access Levels (pg. 42)
J	Scheduling is enabled; See "Schedule Operation" (pg. 53)
K	Current time

Parts of the MANUAL Screen

A	Fill: Allows for Manual Fill of Sump
B	Drain: Allows for Manual Drain of Sump
C	Circulate: Allows for Manual Water Circulation
D	Harvest: Allows for Manual Harvest
E	Back: Goes Back to Previous Screen

Ice Machine Operation (cont.)

Basic Screen & Icon Definitions (cont.)

Real Time Screen

Displays current status of ice machine sensors and components. Green indicates component is energized.

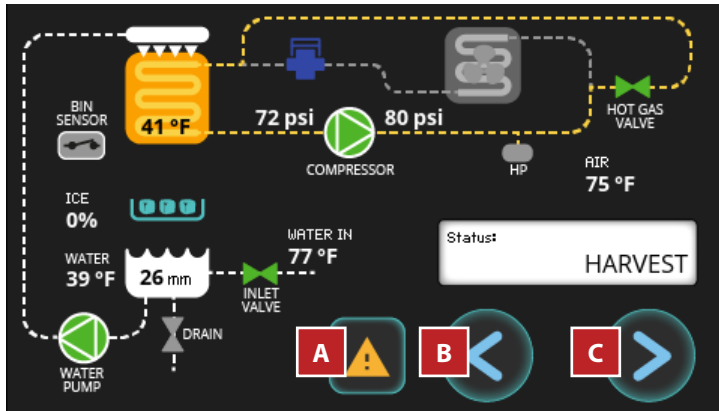

Alarm Log Screen

Shows previous recorded alarms.

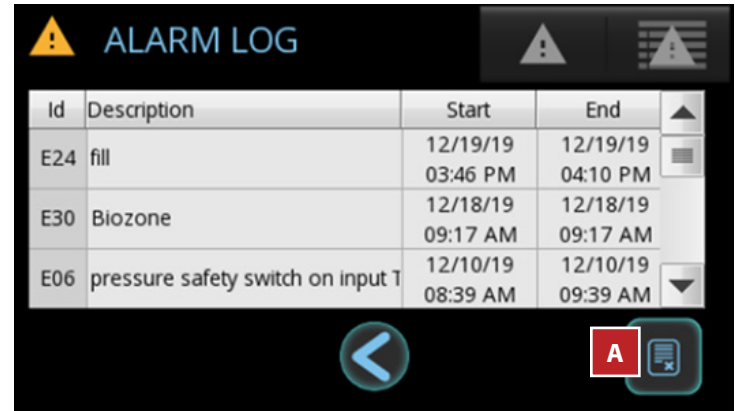

Parts of the REAL TIME screen

A	Access to Alarms
B	Back: Goes Back to Previous Screen
C	Forward: Access to Info Screen

Parts of the ALARM LOG Screen

A	Clears the Alarm Log
---	----------------------

Ice Machine Operation (cont.)

Basic Screen & Icon Definitions (cont.)

Active Alarm Screen

Shows any alarms that are currently active.



Parts of the ACTIVE ALARM Screen

A	Access to Alarm Log
---	---------------------

Status Screen

Shows current mode of operation once the "Make Ice" icon is pressed.



Parts of the STATUS Screen

A	Only Used with Bin Level Management Sensor
B	Turns Ice Machine Off

Ice Machine Operation (cont.)

Basic Screen & Icon Definitions (cont.)

Menu Screen

The default display screen.

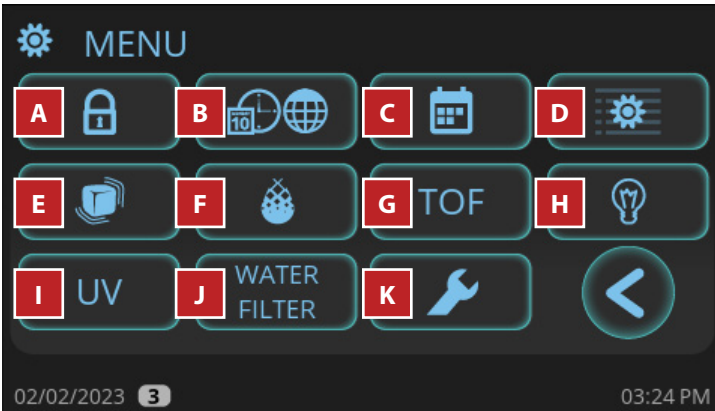

Parts of the MENU Screen

A	Password Protected Access Level Login
B	Set Language, Temperature, Time and Date Format
C	Set Schedule to Turn Ice Machine On and Off
D	Service Settings Screen; Parameter settings
E	Ice Thickness Adjustment
F	Set "Level of Water Hardness or Scale [SCA]"
G	Enable Use of Bin Level Sensor
H	N/A
I	TrueZone™ Status (if so equipped)
J	Water Filter Selection
K	Preventative Maintenance Timers

Ice Machine Operation (cont.)

Basic Screen & Icon Definitions (cont.)

Info Screen

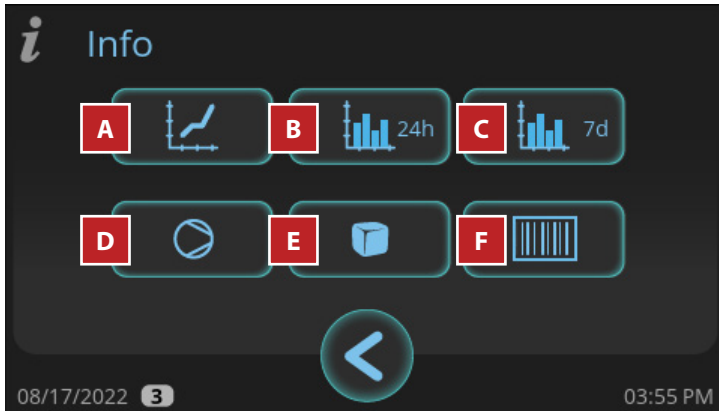

Real Time Graph Screen

Graphs various temperatures and pressures over the last 24 minutes.

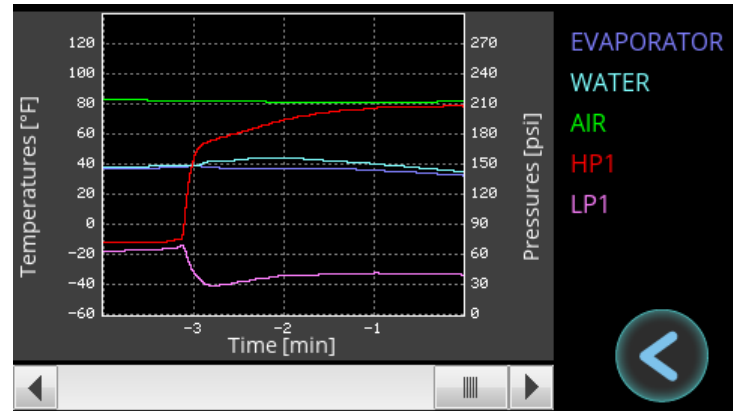

Parts of the INFO Screen

A	Real Time Graph
B	Daily Ice Level
C	Weekly Ice Level
D	Runtime Statistics
E	Cycle History
F	Ice Machine Information

Daily Ice Level Screen

Graphs the ice level over a 24-hour period.

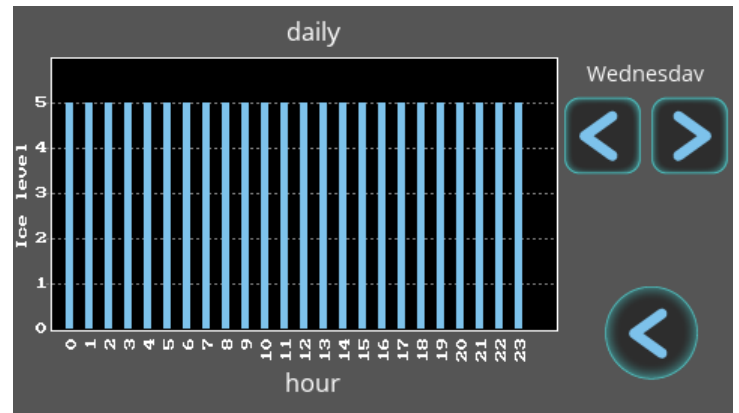

Weekly Ice Level Screen

Graphs the ice level over the past seven days.

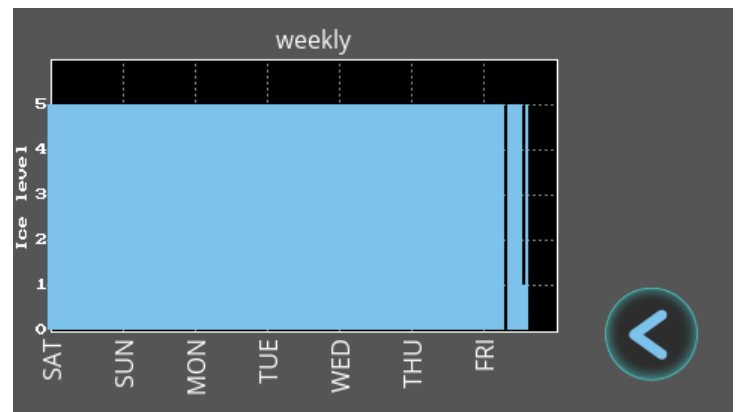

Ice Machine Operation (cont.)

Basic Screen & Icon Definitions (cont.)

Runtime Statistics Screen

Displays runtime percentage, ice capacity, and utility consumption over different periods of time.



Ice Machine Information Screen

Displays model name, serial number, install date, manufactured date, and warranty days remaining.

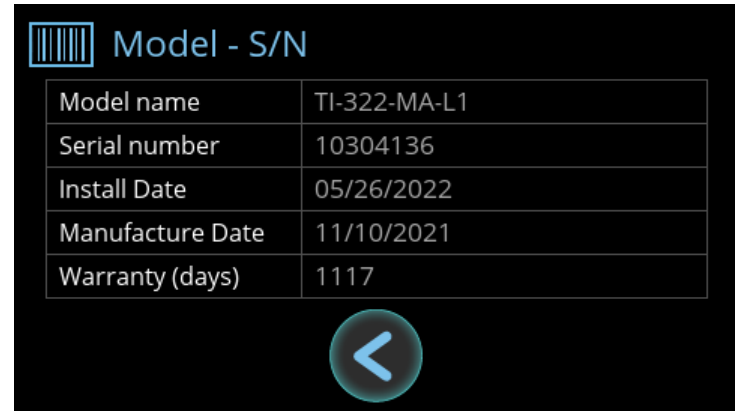

Parts of the RUNTIME STATISTICS Screen

A	Reset Statistics
---	------------------

Cycle History Screen

Displays the last 5 freeze and harvest times.

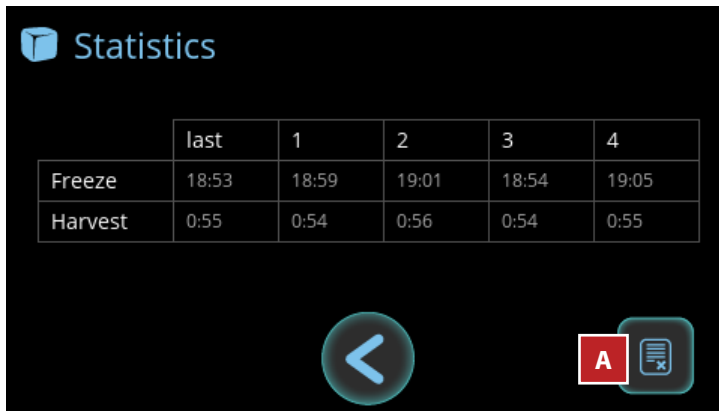

Parts of the CYCLE HISTORY Screen

A	Reset Cycle History
---	---------------------

Ice Machine Operation (cont.)

Reset Reminders

Reset preventative maintenance reminders after performing preventative maintenance.

1. Press **SERVICE**.

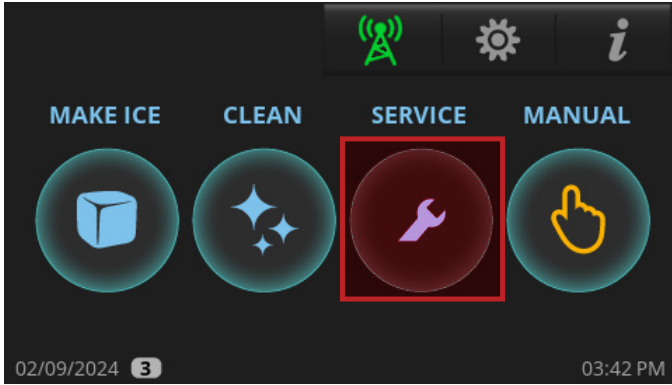

2. In the **Counters** screen, press the appropriate reset reminder icon .

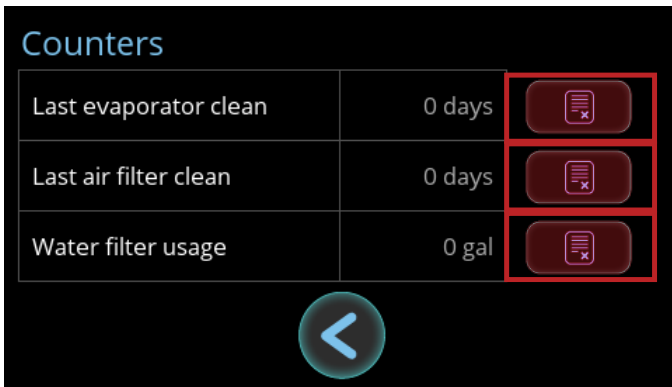

3. In the confirmation screen, press **YES**.

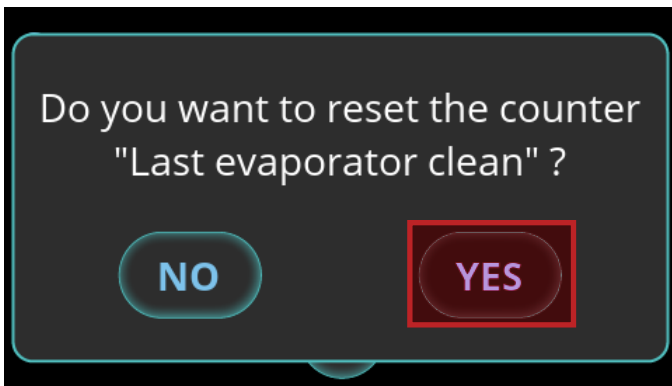

Adjust Reminder Settings

There are three reminders that can be adjusted:

- Evaporator cleaning (Descale/Sanitize).
- Air filter/condenser cleaning.
- Water filter (also see "Water Filter Setup", pg. 26).

1. In the upper right corner of the screen, press Menu .

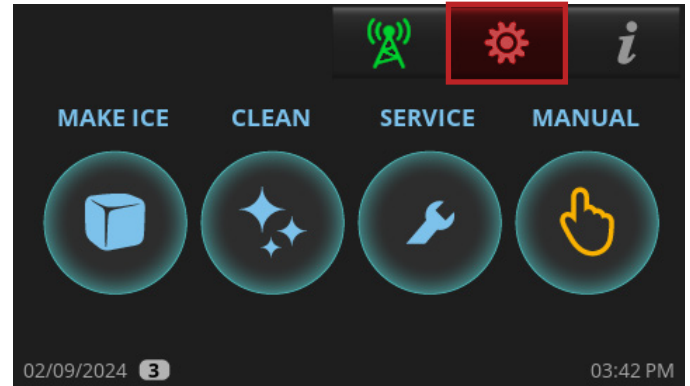

2. In the **Menu** screen, press Parameter Settings .



Ice Machine Operation (cont.)

Adjust Reminder Settings (cont.)

3. With the scroll bar, scroll to the desired parameter:

- #17: Evaporator cleaning reminder.
- #21: Air filter/condenser cleaning reminder.
- #24: Water filter reminder.

Description	Value
16 Toggles the Cleaning Reminder (0=OFF, 1=ON) [CLN]	1
17 Adjusts the time for the clean reminder alarm [CL1]	24 weeks
18 Resets clean reminder counter (0=OFF, 1=ON) [CL2]	0
19 Toggle option to turn Reverse Fan Condenser Cleaning (0=OFF, 1=ON) [RCU]	1
20 Toggles the Filter Reminder (0=OFF, 1=ON) [FLT]	1

11/15/2023 03:02 PM

Description	Value
21 Adjusts the time for the filter reminder alarm [FL1]	3 months
22 Resets filter reminder counter (0=OFF, 1=ON) [FL2]	0
23 Toggles the Water Filter Reminder (0=OFF, 1=ON) [JFL]	1
24 Adjusts the ice quantity for the Water Filter reminder alarm [UF1]	10000 gallons
25 Resets Water Filter reminder counter (0=OFF, 1=ON) [JF2]	0

11/15/2023 03:02 PM

4. Press anywhere on the desired parameter's row. Then, in the number pad, enter the desired setting.



5. Press okay



Ice Machine Operation (cont.)

Startup



- Turn the water supply on to the ice machine and confirm there are no leaks.
- Turn power on to ice machine.
- When the home screen appears, press **CLEAN**  and follow the instructions for SANITIZING. Please see "Cleaning Navigation" (pg. 56).
- Sanitize the ice storage bin liner or dispenser unit using the recommended sanitizer and water solution. See the cleaning sticker or "Descaling and Sanitizing Procedures" (pg. 64).
- When the cleaning cycle is complete, in the home screen, press **MAKE ICE** .
- During the first 5 minutes of the freeze cycle, confirm bin control operation by pushing the damper down and holding it down until ice machine shuts off and the home screen shows **FULL BIN**. The ice machine should shut down in approximately 11 seconds. Release the damper and after one minute the ice machine will restart.
- Watch at least three cycles and confirm that the bridge thickness is correct, (approximately 1/8" (3.18 mm) as shown in fig. 1). The bridge thickness is set at the factory. To adjust, please see "Adjust Ice Thickness" (pg. 50).



Fig. 1. The ice bridge holds the ice cubes together.

Adjust Ice Thickness

1. In the upper right corner of the screen, press Menu .

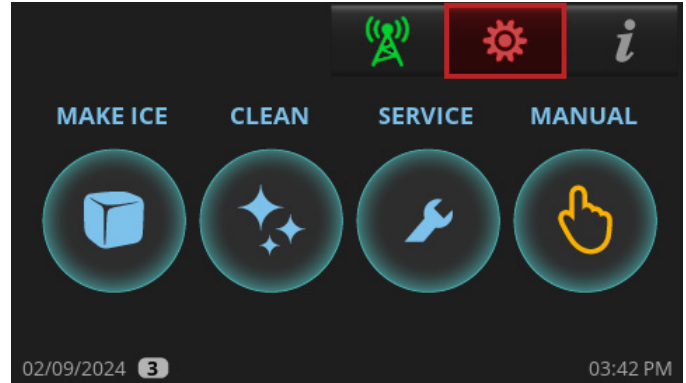

2. In the Menu screen, press **Ice Thickness** .



Ice Machine Operation (cont.)

Adjust Ice Thickness (cont.)

- In the **Ice Thickness** screen, adjust the ice size as needed. The ice machine is factory-set at 0 for the optimal production of pounds of ice per day.
 - For thinner ice, press the +/- key and enter a number 1-6.
 - 6 is the thinnest setting.
 - For thicker ice, enter a number 1-6. 6 is the thickest setting.

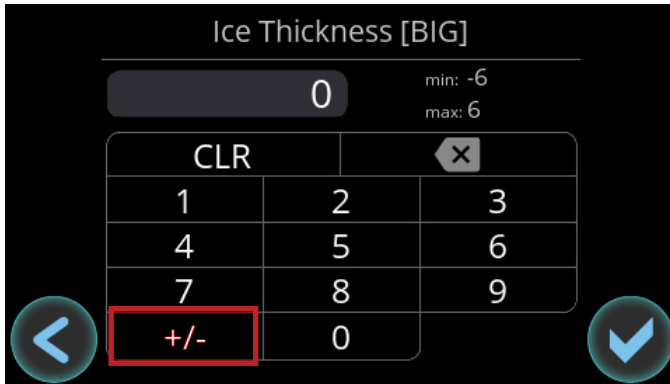

- After setting the ice size, press okay. The display will return to the **MENU** screen.



Ice Machine Operation (cont.)

Sequence of Operation

! USER ACTION!

 Before the ice machine will start **MAKE ICE**  must be pressed and the ice damper must be in place.

! NOTICE!

 Anytime the ice machine is in the **OFF** or **FULL BIN** state, the ice machine will drain water until the sump is empty.

1. Startup Cycle

The startup cycle consists of the self-diagnostic and refrigeration startup sequences.

Self-Diagnostics

Upon startup, the ice machine performs a series of self-diagnostic tests to ensure proper operation of critical components. During this brief period the ice machine will fill and drain with water. This tests component operations as well as helps rid the ice machine of undesirable sediment from the sump.

Refrigeration Startup

The ice machine will then energize the harvest valve and start the refrigeration system in the **HARVEST** cycle. This is to ensure no ice remains on the evaporator before the ice machine enters the **FREEZE** cycle.

2. Freeze Cycle

The water pump energizes, and water is circulated over the evaporator that is being chilled by the refrigeration system. As more heat is removed from the water, it begins to freeze and build ice on the evaporator. As the cycle continues the ice grows thicker and the water level in the sump begins to drop. Once enough water is frozen to form a full sheet of ice the water level is low enough that the water level sensor will initiate the **HARVEST** cycle. The water pump and fan motor(s) will de-energize.

3. Harvest Cycle

The harvest valve, drain valve and water inlet valve energize, which allows sediment to drain and starts to refill the sump water for the next cycle. As hot refrigerant flows into the evaporator, it begins to warm the evaporator enough to release ice from the evaporator. The ice will fall and contact the damper door at the bottom of the evaporator. The damper will pivot down to an open position and, if the ice storage unit is not full, the damper will pivot back up to closed position. This signals the ice machine to start another **FREEZE** cycle. The ice machine will continue to repeat the **FREEZE** and **HARVEST** cycles until the ice storage unit is full.

4. Full Bin

When the ice storage unit is full, the sheet of ice will prevent the damper door from pivoting back up to a closed position. After several seconds of the damper remaining open, the ice machine will shut off and display **FULL BIN**. The drain valve will energize and drain the remaining water from the sump to prevent sediment build-up. Once the ice melts or ice is removed from the ice storage unit, the damper will pivot back to a closed position and the ice machine will restart in the **STARTUP** cycle.

Ice Machine Operation (cont.)

Schedule Operation

Set a schedule to turn the ice machine on and off automatically.

Turn Schedule On

1. In the upper right corner of the screen, press **MENU** .

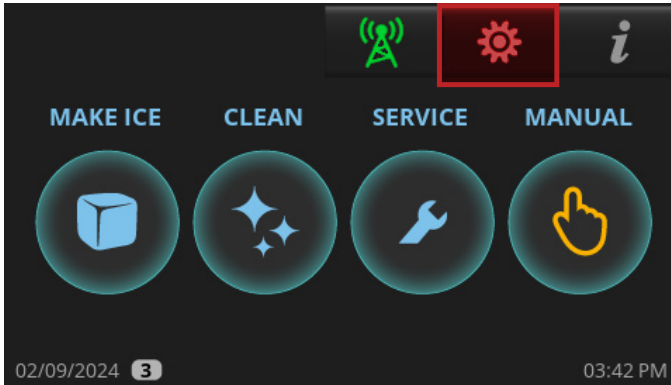

2. In the **MENU** screen, press **SCHEDULING** .



3. In the **SCHEDULING** screen, press **ENABLE**.

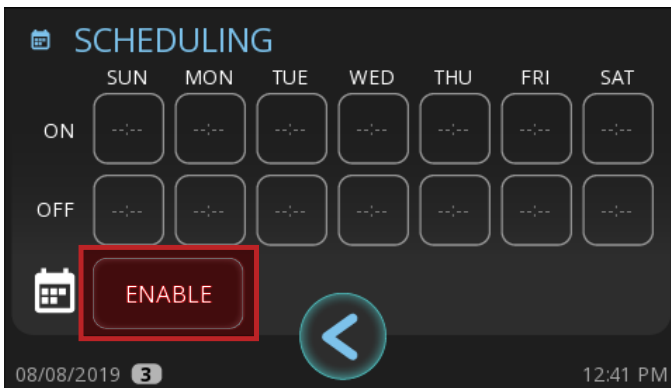

4. In the **ON** row, press a day of the week.

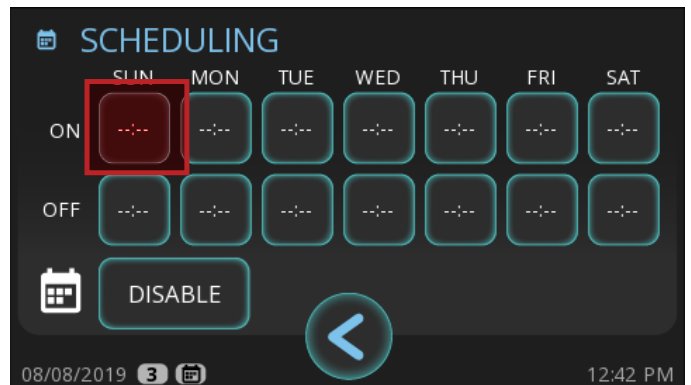

5. In the **ON** screen, enter the desired time for the ice machine to turn on, and then press okay .



6. In the **SCHEDULING** screen, in the **OFF** row, press the same day of the week.

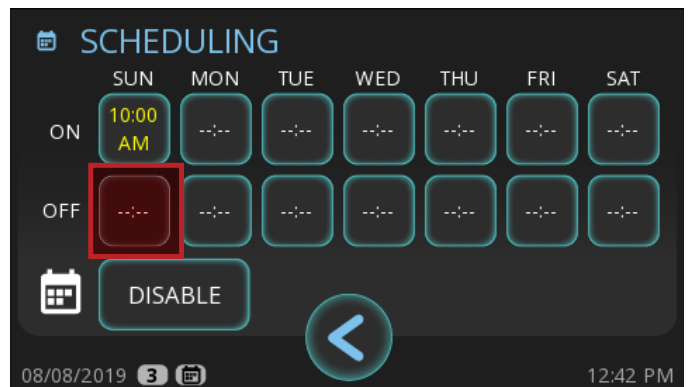

Ice Machine Operation (cont.)

Schedule Operation (cont.)

7. In the **OFF** screen, enter the desired time for the ice machine to turn off, then press okay.

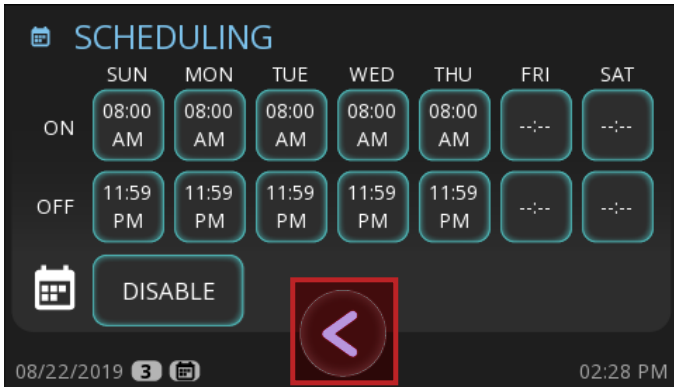

8. Repeat steps 4-7 as needed for each day of the week. Then, press return (←) to go back to the **MENU** screen.



Scheduling is enabled when the small calendar icon (📅) appears in the lower left corner of the screen.

Turn Schedule Off

1. In the upper right corner of the screen, press **MENU** (⚙️).

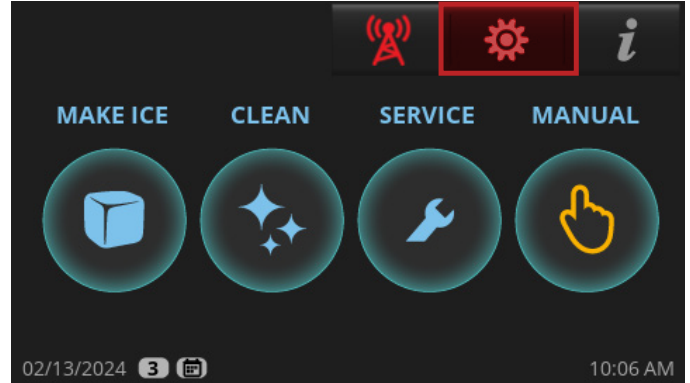

2. In the **MENU** screen, press **SCHEDULING** (📅).



3. In the **SCHEDULING** screen, press **DISABLE**.

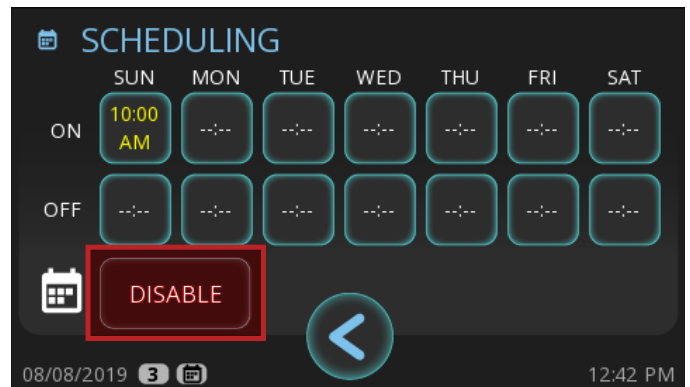

Ice Machine Operation (cont.)

Schedule Operation (cont.)

- After the **ON** and **OFF** rows clear, press return  to go back to the **MENU** Screen.

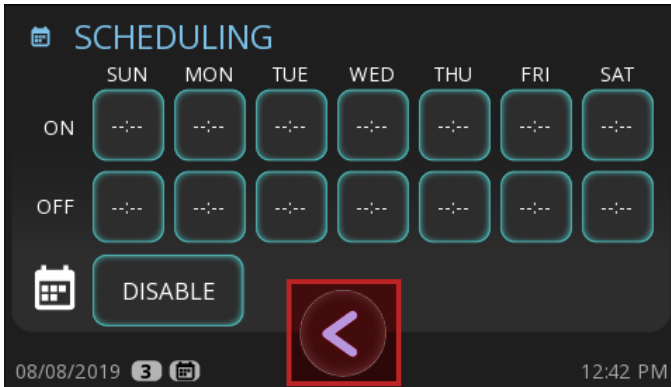

Scheduling is disabled when the small calendar icon **does not** appear in the lower left corner of the screen.

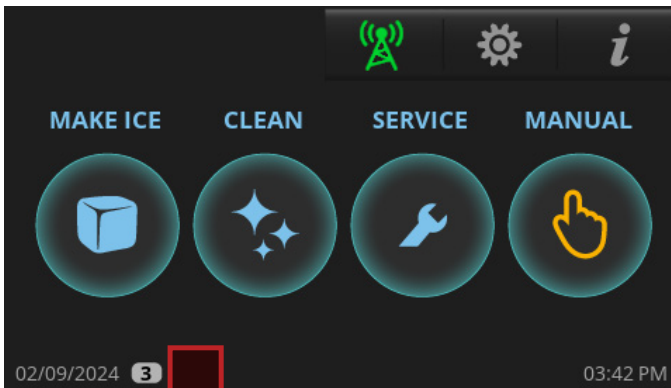

Adjust for Water Quality

The water quality setting allows your ice machine to easily accommodate different levels of water quality/hardness/scale.

The available settings range from 0 (soft water/low scale) to 5 (hard water/high scale). See fig.1.

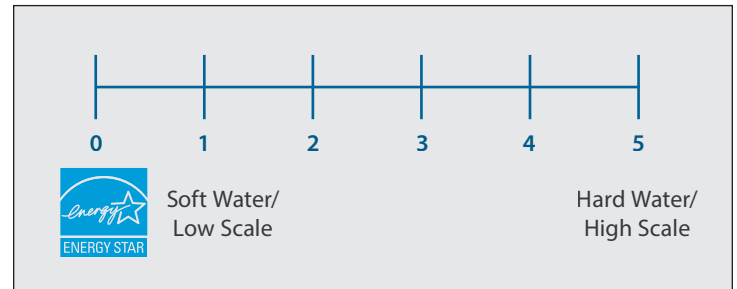



Fig.1. Water quality setting range.

The unit default setting is 0 to maintain energy star operation. If you are unsure of your water quality, check your water with a water quality test kit (not provided by True).

- In the upper right corner of the screen (where it appears), press Menu .
- In the **MENU** screen, press Set Water Hardness or Scale .



- In the **Levels of water hardness or scale** screen, enter the desired setting, and then press okay .

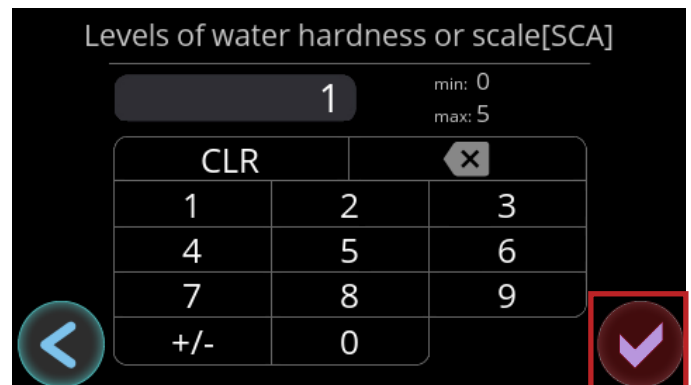

Ice Machine Operation (cont.)

Cleaning Navigation

 **The procedure that follows is not the cleaning and sanitizing instructions.** This section details the navigation to start a descaling and or sanitizing cycle. Please see "Descaling and Sanitizing Procedures" (pg. 64) for full instruction on descaling and sanitizing the machine.

1. In the home screen, press **CLEAN** .

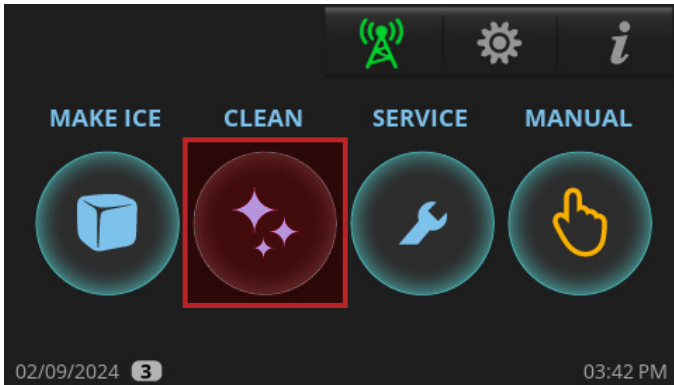

2. Press the desired cleaning option.
DESCALE: Descaling with approved True Mfg. descaler only.
SANITIZE: Sanitizing with bleach only.
BOTH: Descale and Sanitize.



3. If **DESCALE** or **BOTH** was pressed, choose between the following options.
PREVENTATIVE MAINTENANCE: Shorter cycles; use between bi-annual maintenance.
STANDARD: Normal cycle times; use when performing regular bi-annual maintenance.
HEAVY: Longer cycle times; use when heavy scaling on parts is obvious.



4. When "Would you like the unit to start making ice once descaling and/or sanitizing is complete?" appears, press either **NO** or **YES**. The ice machine will go into PRE-CLEANING.

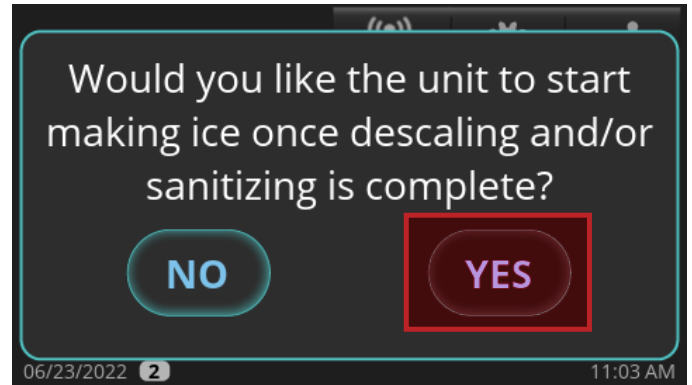

Ice Machine Operation (cont.)

Cleaning Navigation (cont.)

5. Wait for the ice machine to run through the PRE-CLEANING sequence (FILL, PUMP, DRAIN, and HARVEST). If there is enough water in the sump at the start of CLEAN, it will go through a DRAIN sequence before FILL. The compressor will start during the HARVEST sequence to ensure there is no ice on the evaporator and will shut off before the cleaning sequence continues.
6. When **ADD CLEANER** appears, add the proper amount of descaler or sanitizer as directed in "Descaling and Sanitizing Procedures". Then press **OK** button.

NOTICE > The cleaning cycle will not proceed from this point unless OK is pressed after adding the TRUE ice machine descaler or chlorine bleach (5.25% sodium hypochlorite).

7. Wait for the ice machine to complete the Descaling and Sanitizing sequences. There will be a series of rinse, drain and fill sequences during this time.

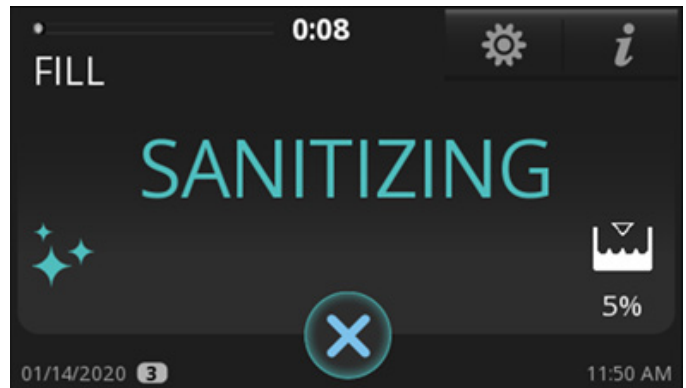
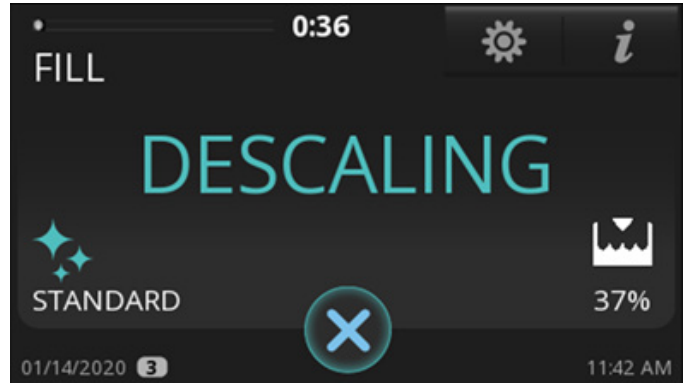
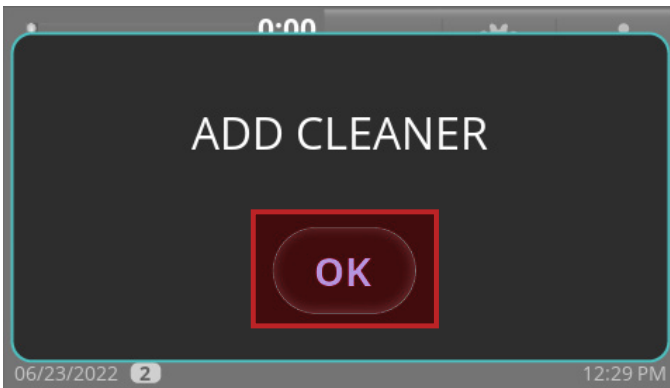

Maintenance & Servicing

Maintenance & Servicing

⚠ WARNING!	
	<p>Only qualified technicians should install and service the ice machine. For assistance finding a qualified technician, please visit our Service Company Locator at truemfg.com/support/service-locator/. True is solely the appliance manufacturer and is not responsible for installation, service, and routine maintenance. Turn off and lockout all utilities (gas, electric, water) according to approved practices during maintenance or servicing.</p>
 	<p>The appliance owner is responsible for performing a Personal Protective Equipment (PPE) Hazard Assessment and ensuring adequate protection during maintenance and cleaning procedures.</p> <p>Use appropriate tools, safety equipment, and PPE during installation and servicing.</p>
	<p>Sharp Edges!</p> <p>Take care when moving, installing, cleaning, servicing, and maintaining the ice machine to avoid cuts. Be sure to take care when reaching under the ice machine or handling metal components.</p> <ul style="list-style-type: none"> Stay clear of pinch point areas, such as the space between appliance doors and surrounding cabinetry. Take care closing doors with children nearby.
	<p>Risk of Electric Shock or Burn!</p> <p>Toggle the rocker switch does not remove power from all components. Unplug the ice machine or turn off the power supply before installation or servicing.</p> <ul style="list-style-type: none"> DO NOT clean your ice machine with a pressure washer or hose.

⚠ WARNING! (cont.)	
	<p>Tip Over Hazard!</p> <p>Ice machine may pose a tipping hazard when uncrating, installing, or moving the appliance. Take appropriate safety precautions. Use of tip over restraints may only reduce (not eliminate) the tipping hazard. Never allow children to climb or hang on drawers, doors, or shelves. Two or more people are required to move this equipment to prevent tipping.</p>
	<p>Crush or Cut Hazard!</p> <p>Keep clear of moving components. Components can move without warning unless power is disconnected.</p>
	<p>Optical Radiation Hazard! UV Light!</p> <p>Invisible laser radiation. Do not look directly at light. Always disconnect power before servicing the lamp.</p>
	<p>Replace component parts with original equipment manufacturer (OEM) components to minimize the risk of possible ignition due to incorrect parts or improper service.</p>
	<p>Moving Parts Hazard!</p> <p>Moving parts can cut. Keep hands clear when panels are removed.</p>

ⓘ NOTICE!	
	<p>The appliance owner is responsible for maintaining the ice machine as described in this document. Routine care and maintenance procedures are not covered by True's warranty. Do not use power cleaning equipment, steel wool, scrapers or wire brushes on stainless steel or painted surfaces.</p>

Maintenance & Servicing (cont.)

Removal from Service & Winterization

If storing your ice machine for an extended time or in sub-freezing temperatures, winterize the appliance.





! USER ACTION!	
!	<p>DO NOT ALLOW THE ICE MACHINE TO BE EXPOSED TO TEMPERATURES BELOW 32°F (0°C) WITHOUT WINTERIZING THE UNIT AS THIS WILL CAUSE ANY WATER IN THE MACHINE TO FREEZE. FAILURES CAUSED BY EXPOSURE TO FREEZING TEMPERATURES ARE NOT COVERED BY THE WARRANTY.</p>

! NOTICE!	
!	<p>If the ice machine will not be used for 2-3 days under normal conditions turn the unit off .</p>

7. When complete, press cancel  to exit the manual drain operation.

! WARNING!	
	<p>DO NOT rinse the parts with clean water after sanitizing. Let them air dry.</p>

8. Disconnect electrical power at the main disconnect/circuit breaker.
9. Fill spray bottle with sanitizer and spray all interior food zone surfaces.
10. Reinstall all panels.

1. Clean and sanitize the ice machine. See "Descaling and Sanitizing Procedures" (pg. 64).
2. Turn off the water supply.
3. Disconnect and drain the water supply line at the rear of the ice machine and drain the sump.
4. In the Home Screen, press **MANUAL** . Then, press **FILL** . Wait for 3 seconds then blow compressed air in the water supply fitting in the rear of the ice machine to remove all water.
5. When complete, press cancel  to exit the manual drain operation.
6. In the Home Screen, press **MANUAL**. Then, press **DRAIN** . Wait for 3 seconds then blow compressed air in the drain fitting in the rear of the ice machine to remove all water.

Maintenance & Servicing (cont.)

Cleaning the Ice Level Sensor

Routine cleaning of the ice level sensor is not required. Cleaning is only necessary if the lens has any obstructions (smudges, water droplets, dust, scale, condensation, etc.).

1. Remove the grill.
 - a. **Top Grill Models** – Loosen the top right and left screws that secure the front grill on the ice machine and remove
 - b. **Side Grill Models** – Loosen door screws then open the door and grill.
2. Remove the top panel and the right-side panel.
3. Remove the 2 screws holding the bracket to the plastic case. See fig. 1.
4. Pull the assembly out and flip it upside down to reveal the lens. See fig. 2.
5. With a clean microfiber cloth, wipe the lens from the outside of the housing. The side in the housing does not require cleaning.

NOTICE Any smudges or residue can result in the sensor showing a false 100% value.
6. Insert the assembly back into the ice machine ensuring the assembly sits down in the plastic case cutout.
7. Secure bracket to the side of the plastic case with the bracket screws while holding the assembly down to ensure it is sitting properly.

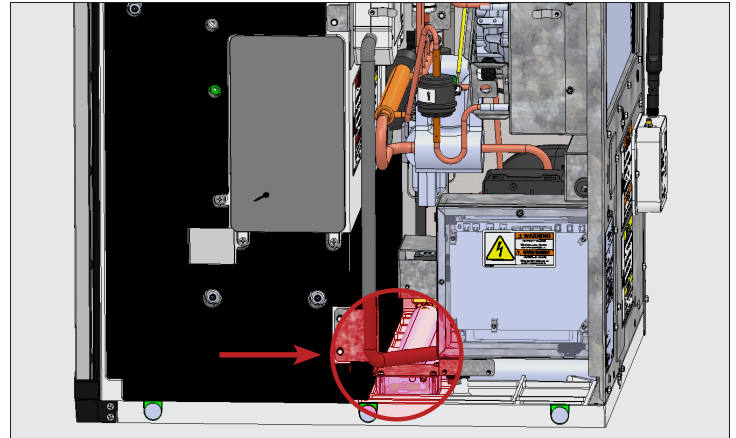

Fig. 1. Ice level sensor assembly location.

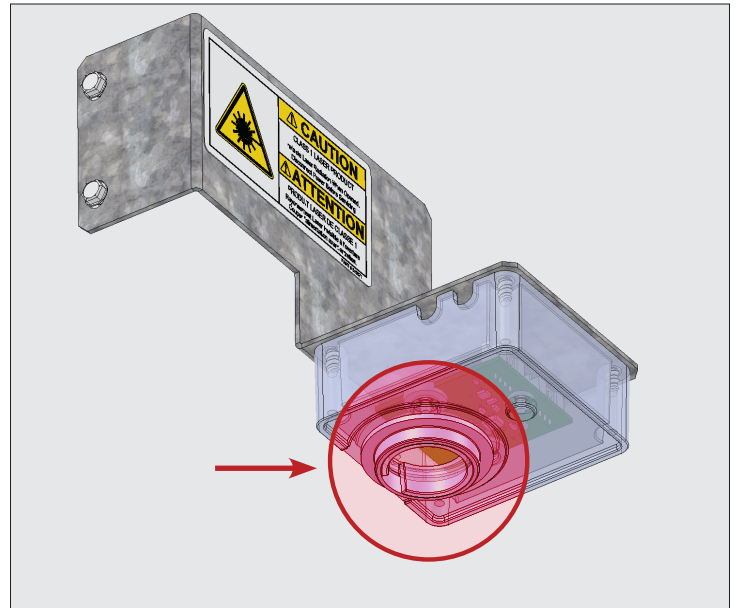





Fig. 2. Ice level sensor lens location.

TrueZone™ Air & Surface Clean-In-Place (CIP) System (Optional Accessory)

TrueZone™ is an air and surface clean-in-place (CIP) system for ice machines. This process inhibits the growth of common micro-organisms on all exposed food zone surfaces and kills flu and other viruses. The CIP system also helps prevent the formation of slime, mold, and yeast, in addition to controlling bacteria in hard-to-reach areas that are difficult to clean. The UV bulb lasts for 9,000 hours.

Maintenance & Servicing (cont.)

Bulb Replacement Instructions

⚠ WARNING!	
	<p>Optical Radiation Hazard! UV Light! Invisible laser radiation. Do not look directly at light. Always disconnect power before servicing the lamp.</p>
	<p>Electrical Shock or Burn Hazard! High Voltage Inside!</p> <ul style="list-style-type: none"> • Toggling the rocker switch does not remove power from all components. Unplug the ice machine or turn off the power supply before servicing. • Open circuit voltage and voltage to ground 600V.
	<p>Sharp Edges! Take care when installing, cleaning, servicing, and maintaining the ice machine to avoid cuts. Be sure to take care when reaching under the appliance or handling metal components.</p>
	<p>Do not dispose of lamps with household waste. Lamps contain mercury. Recycle the lamps so the mercury, metal and glass can be reclaimed, and they do not enter our water system. Visit search.earth911.com and search for a local recycling solution.</p>

📌 NOTICE!	
	<p>The bulb counter automatically resets/recalculates when replaced. Any errors/alarms automatically clear.</p>

1. Disconnect power to the ice machine or turn off the power supply.
 - NOTICE >** Let the bulb cool at least two minutes before proceeding.
2. Open the front panel. See fig. 1.
3. Remove the top panel or right panel to access the UV bulb.
4. Locate the TrueZone UV system. See figs. 2 and 3.
5. **Right Access Only:** Remove the TrueZone bracket screws and slide the TrueZone UV system towards you. See fig. 3
6. Remove the bulb assembly from the TrueZone UV system.
7. Disconnect the electrical harness from the bulb assembly.

8. Connect the replacement bulb to the electrical harness.
9. Install the replacement bulb assembly.
 - NOTICE >** Be sure the notch in the rubber seal faces the TrueZone's outlet air tube. See fig. 4.
10. Restore power and verify operation.
11. If applicable, reinstall the TrueZone UV system. See fig. 3.
12. Reinstall all covers and panels removed to access the bulb.



Fig. 1. Front panel screw locations.

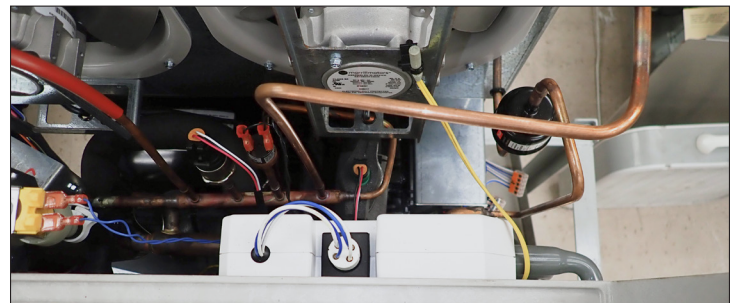

Fig. 2. TrueZone UV system top view.



Fig. 3. TrueZone UV system side view. TrueZone bracket screw locations.

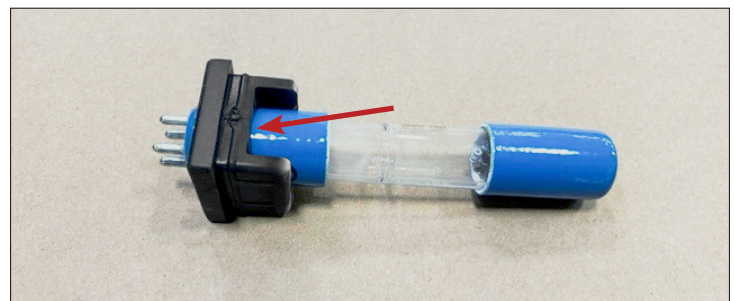





Fig. 4. Rubber seal notch.

Maintenance & Servicing (cont.)

Cleanup Procedure for Accidental Lamp Breakage

⚠ WARNING!	
  	<p>The appliance owner is responsible for performing a Personal Protective Equipment (PPE) Hazard Assessment and ensuring adequate protection during maintenance and cleaning procedures. Use appropriate tools, safety equipment, and PPE during installation and servicing.</p>

These lamps contain a small amount of mercury sealed within the glass tubing. When a lamp breaks, some of this mercury is released as mercury vapor. The broken lamp can continue to release mercury vapor until it is cleaned and removed from the area. These lamps fall under the same category as compact fluorescent light (CFL). To minimize exposure to mercury vapor, the EPA recommends that residents follow the cleanup and disposal steps described below.

This cleanup guidance represents the minimum actions recommended to clean up a broken CFL. For more detailed instructions and information, please see U.S. Environmental Protection Agency (EPA) website at epa.gov.

The most important steps to reduce exposure to mercury vapor from a broken lamp include the following:

Before Cleanup...

1. Have people and pets leave the room
2. Air out the room 5-10 minutes by opening a window or door to the outdoor environment.
3. Shut off any central forced air heating/air-conditioning systems. Collect materials needed to clean up broken lamp
 - Stiff paper or cardboard
 - Sticky tape
 - Damp paper towels or disposable wet wipes (for hard surfaces)
 - A glass jar with a metal lid or a sealable plastic bag

During Cleanup...

1. Thoroughly collect broken glass and visible powder.

⚠ WARNING!	
	<p>Do not vacuum broken glass fragments! Vacuuming is not recommended unless broken glass remains after all other cleanup steps have been taken. Vacuuming could spread mercury-containing powder or mercury vapor.</p>

2. Place cleanup materials in a sealed container.

After Cleanup...

3. Promptly place all lamp debris and cleanup materials outdoors in a trash container or protected area until materials can be disposed of. Avoid leaving any lamp fragments or cleanup materials indoors.

NOTICE > Some localities require fluorescent lamps (broken or unbroken) be taken to a local recycling center. Check with your local government about disposal requirements in your area. If there is no such requirement, you can dispose of the materials with your household trash.

4. If practical, continue to air out the room where the lamp was broken and leave the heating/air-conditioning system shut off for several hours.

Maintenance & Servicing (cont.)

Recommended Cleaning Frequency

NOTICE!	
	<p>Maintenance procedures are not covered by warranty.</p>

When using a non-True Manufacturing bin or dispenser, follow the maintenance guidelines of the manufacturer of the product.

The maintenance schedule below is a guideline. More frequent maintenance may be required depending on water quality, environment, and local sanitation regulations.

It is the User's responsibility to keep the ice machine and ice storage bin (or dispenser if applicable) in a sanitary condition in accordance with the instructions in this manual.

Recommended Cleaning Schedule		
Frequency	Component	Task
Daily	Ice Scoop	Clean with sanitizer or neutral cleaner and rinse thoroughly.
Monthly	Water Filter	<ul style="list-style-type: none"> • Check for proper outlet pressure and change if less than 20 psig (138 kPa) • Check the "Water Passed Through Filter" counter in the "Counters" section in the "MENU" screen.
	Ice Machine and Bin Exterior (or dispenser, if applicable)	<ul style="list-style-type: none"> • Wipe surfaces with a damp cloth rinsed in water to remove dust and dirt from the outside of the ice machine and bin. For greasy residue use a damp cloth rinsed in a mild dish soap and water solution. Wipe dry with clean, soft cloth. • The exterior panels have a clear coating that is stain resistant and easy to clean. Products containing abrasives will damage the coating and scratch the panels.
	Air Filter	Inspect and wash with warm water and neutral cleaner if dirty.
Quarterly	Ice Machine	Preventative Maintenance Cleaning and Sanitizing Procedure.
Bi-Annually	Ice Machine and Bin (or dispenser, if applicable)	Descaling and Sanitizing Procedure.
As Directed by Service Professional	Air Cooled Condenser	In areas with airborne contaminants (i.e. grease), chemical cleaning of the condenser will be required. This should only be done by a service professional.

Maintenance & Servicing (cont.)

Exterior Cleaning

! USER ACTION!

	If a greasy residue remains on the surface, use a mild dish soap and water solution with a damp cloth. Wipe dry with a clean, soft cloth.
--	---

! NOTICE!

	<p>The exterior panels have a clear coating that is stain resistant and easy to clean. Products containing abrasives will damage the coating and scratch the panels.</p> <ul style="list-style-type: none"> Never use steel wool or abrasive pads. Never use chlorinated, citrus based or abrasive cleaners on exterior panels and plastic trim pieces.
--	---

- Clean the area around the ice machine as needed to maintain cleanliness and efficient operation.
- Wipe surfaces with a damp cloth rinsed in water to remove dust and dirt from the ice machine's exterior.

Descaling & Sanitizing Procedures (biannually)

! DANGER!

 	<p>HIGHLY CORROSIVE CLEANING CHEMICALS.</p> <p>Avoid contact with eyes and skin. Wear eye protection and chemical-resistant rubber gloves when handling.</p>
------------------	---

! WARNING!

	<p>Toxic Material Hazard!</p> <p>DO NOT MIX DESCALER WITH SANITIZER.</p> <p>Harmful fumes may be generated.</p>
	<p>Optical Radiation Hazard! UV Light!</p> <p>Invisible laser radiation. Do not look directly at light. Always disconnect power before servicing the lamp.</p>

! USER ACTION!

	<p>True recommends using TRUE Ice Machine Descaler. To purchase, contact True Parts Department at 800-424-8783 or partsinquiries@truemfg.com.</p> <p>If using a non-TRUE descaler (Nickel-safe) recommended dilution for soaking parts is 3 fl oz (88.7 mL) per 1 gal (3.78 L) and recommended amount for evaporator cleaning is 6-8 fl oz (177.4-236.6 mL).</p> <p>Use of non-recommended descaler may void warranty.</p>
--	--

Maintenance & Servicing (cont.)

Descaling & Sanitizing Procedures (biannually) (cont.)

If necessary, cancel the descaling or sanitizing sequences by pressing cancel **X**. However, the sequences cannot be cancelled after cleaner or sanitizer has been added to the sump and **OK** has been pressed.

Descaling

1. Remove all ice from the bin (or dispenser if applicable).
2. Loosen the front panel screws and open the front panel.
3. In the home screen press **CLEAN** .

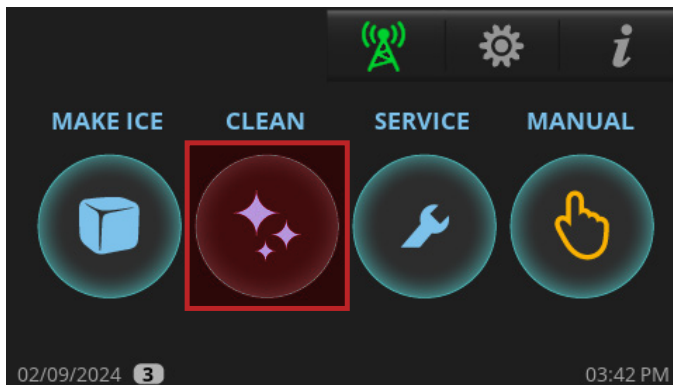

4. Press **DESCALE**.



5. Choose between the options.
 - PREVENTATIVE MAINT.:** Shorter cycles; use between bi-annual maintenance.
 - STANDARD:** Normal cycle times; use when performing regular bi-annual maintenance.
 - HEAVY:** Longer cycle times; use when heavy scaling on parts is obvious.



6. When "Would you like the unit to start making ice once descaling and/or sanitizing is complete?" appears, press **NO**.

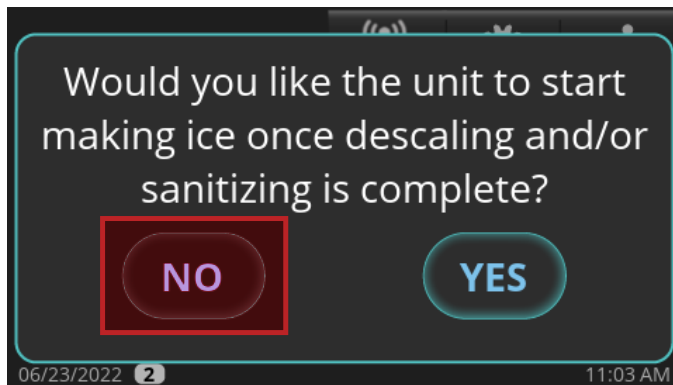

7. Wait for the ice machine to run through the PRE-CLEANING sequence (FILL, PUMP, DRAIN, and HARVEST). If there is enough water in the sump at the start of CLEAN, it will go through a DRAIN sequence before FILL. The compressor will start during the HARVEST sequence to ensure there is no ice on the evaporator and will shut off before the cleaning sequence continues.

Maintenance & Servicing (cont.)

Descaling & Sanitizing Procedures (bi-annually) (cont.)

8. When **ADD CLEANER** appears, open the water curtain and pour 10 oz (296 mL) of TRUE ice machine descaler between the evaporator and the damper.

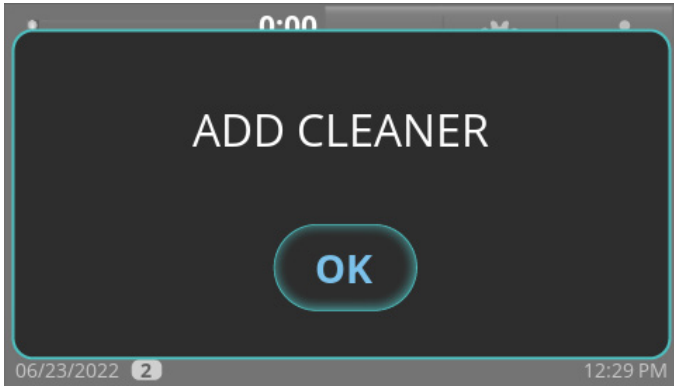

9. After adding descaler, press **OK**. The display will then show the sequence status.

NOTICE > The sequence will not proceed from this point unless OK is pressed after adding the descaler.

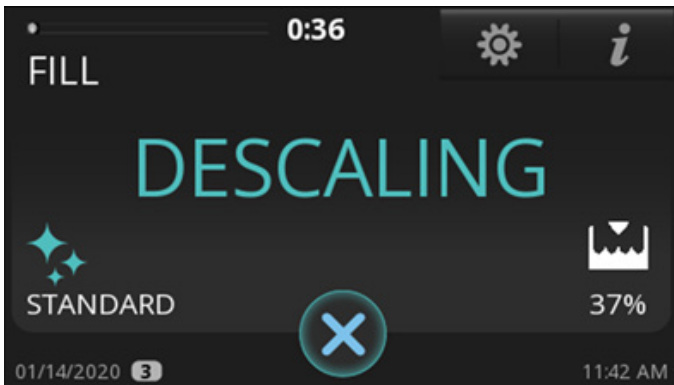

10. Wait for the ice machine to complete the cleaning cycle and return to the home screen.

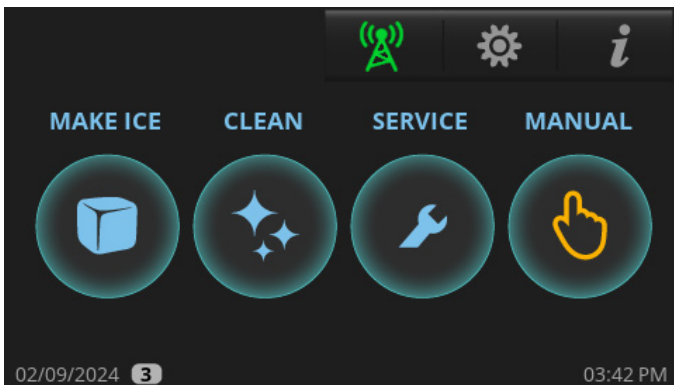

11. Prepare a solution of 10 fl oz (296 mL) TRUE ice machine descaler to 1 gal (3.8 L) of warm water.

NOTICE > In cases where scale build up is particularly heavy, substitute equal amounts ice machine descaler and warm water.

12. Remove parts for cleaning. See below.

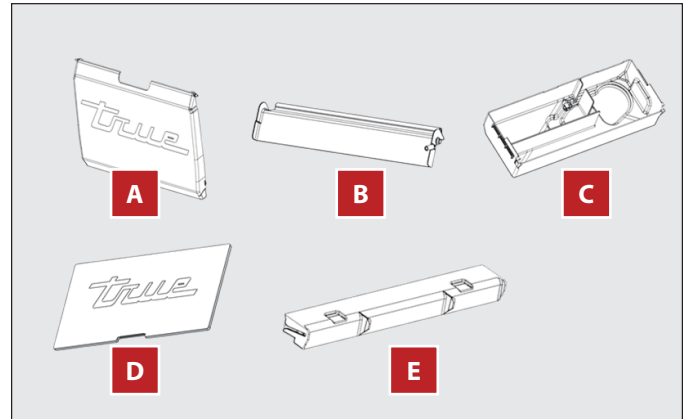

A. Water Curtain: Remove by placing one hand over the top lip of the curtain and the other hand on the side of the curtain. Gently flex the curtain on the side toward the center while gently pulling the top outward.

B. Damper: Remove by pushing the damper down until horizontal, pull forward gently until it stops and then push down until it stops and pull forward.

C. Sump: Reach under the sump and pull off the drain hose. Then place fingers between the left or right bulkhead wall and the side of the sump. Place the other hand over the lip of the sump. Push the sump with your fingers toward the opposite bulkhead wall while pulling the sump in the same direction with your hand until it comes out of the snap bracket. Repeat the process on the other side and remove the sump.

D. Evaporator Area Cover: Remove by pushing up from the inside of evaporator section.

E. Water Distributor: Remove by grabbing the two distributor tabs and pull up slightly then forward.

13. With half of the solution, soak the parts for 5-10 minutes (if heavily scaled, 15-20 minutes). Then with a **soft nylon bristle brush**, cloth, or sponge, thoroughly clean the parts.

Maintenance & Servicing (cont.)

Descaling & Sanitizing Procedures (bi-annually) (cont.)

14. Thoroughly rinse the parts with clean water. With the remaining solution and a **soft nylon bristle brush**, cloth, or sponge, thoroughly clean all food zone areas (shaded components) of the ice machine. These areas include the following:

- Side walls
- Plastic evaporator top frame (where distributor is installed)
- Plastic evaporator sides and bottom
- Water pump base
- Water pump tubing
- Sump drain tubing
- Water level air column
- Base (area above the sump, under the evaporator)

15. Thoroughly clean all food zone areas of the ice bin (or dispenser, if applicable).

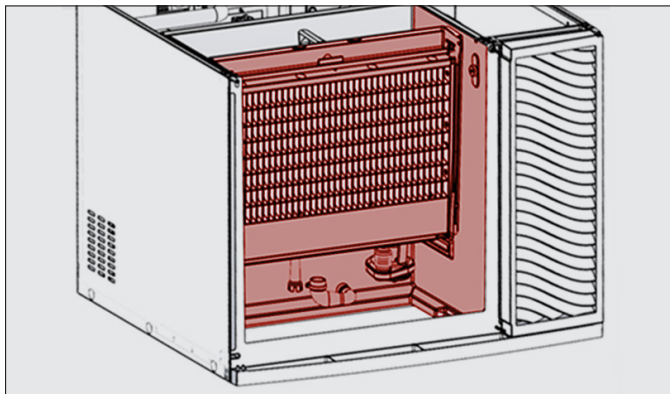

Front View

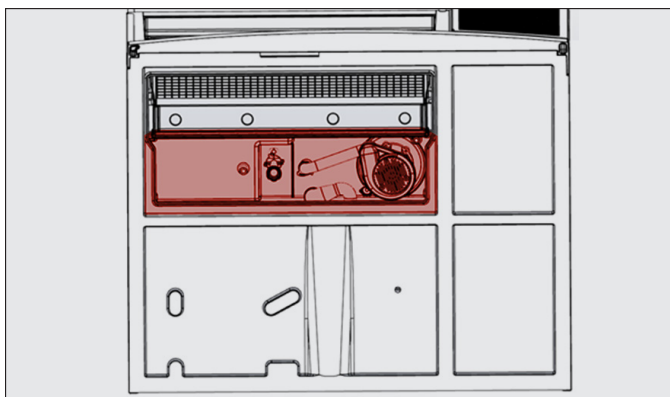

Bottom View

Sanitizing

1. Prepare a solution of 1.5 fl oz (44mL) chlorine bleach (5.25% sodium hypochlorite) to 3 gal. (11.4 L) of warm water. Use half of the solution to sanitize all the removed parts from the cleaning procedure.
2. Remove parts for cleaning. See below.

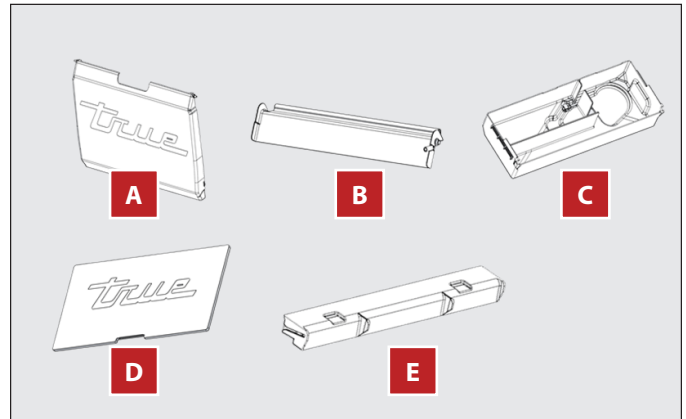

A. Water Curtain: Remove by placing one hand over the top lip of the curtain and the other hand on the side of the curtain. Gently flex the curtain on the side toward the center while gently pulling the top outward.

B. Damper: Remove by pushing the damper down until horizontal, pull forward gently until it stops and then push down until it stops and pull forward.

C. Sump: Reach under the sump and pull off the drain hose. Then place fingers between the left or right bulkhead wall and the side of the sump. Place the other hand over the lip of the sump. Push the sump with your fingers toward the opposite bulkhead wall while pulling the sump in the same direction with your hand until it comes out of the snap bracket. Repeat the process on the other side and remove the sump.

D. Evaporator Area Cover: Remove by pushing up from the inside of evaporator section.

E. Water Distributor: Remove by grabbing the two distributor tabs and pull up slightly then forward.

Maintenance & Servicing (cont.)

Descaling & Sanitizing Procedures (bi-annually) (cont.)

3. Soak all the parts in the solution for one minute and then allow them to air dry.

⚠ WARNING!	
	<p>DO NOT rinse the parts with clean water after sanitizing. Let them air dry.</p>

4. With a spray bottle, heavily spray all food zone areas with the sanitizing solution. These areas include the following:

- Side walls
- Plastic evaporator top frame (where distributor is installed)
- Plastic evaporator sides and bottom
- Water pump base
- Water pump tubing
- Sump drain tubing
- Water level air column
- Base (area above the sump, under the evaporator)

5. Reinstall the sanitized components and wait 10 minutes.

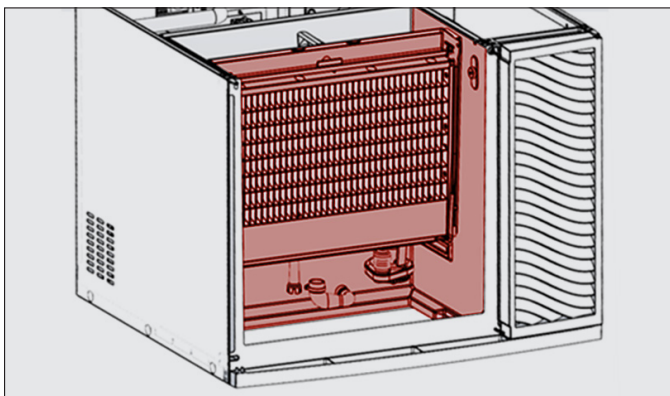

Front View

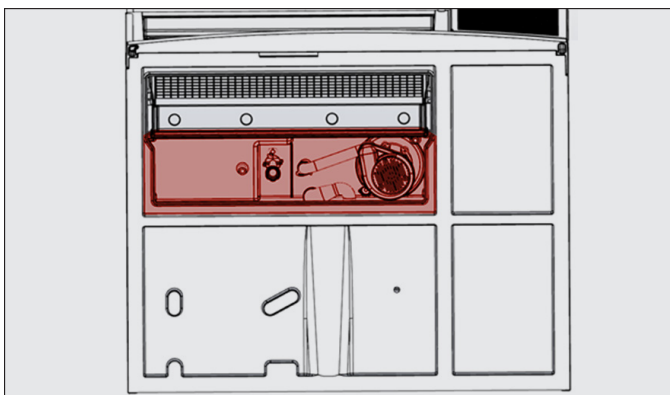

Bottom View

6. In the home screen, press **CLEAN** .

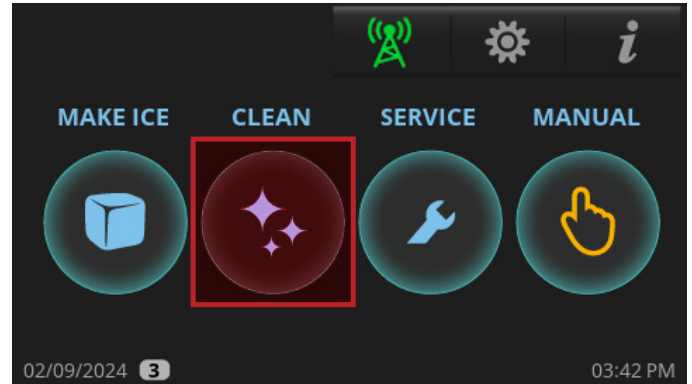

7. Press **SANITIZE**.



8. When "Would you like the unit to start making ice once descaling and/or sanitizing is complete?" appears, press either **NO** or **YES**. The ice machine will go into **PRE-CLEANING**.

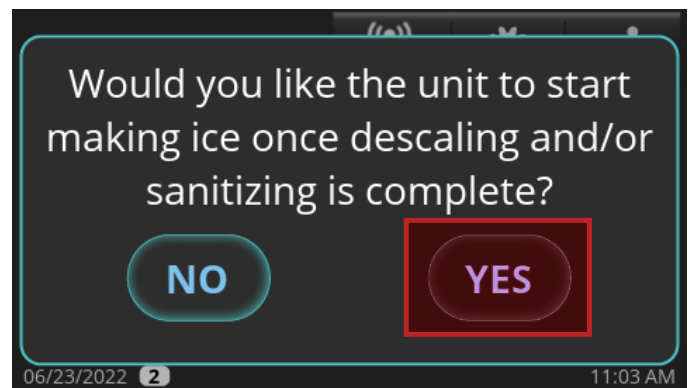

Maintenance & Servicing (cont.)

Descaling & Sanitizing Procedures (bi-annually) (cont.)

9. Wait for the ice machine to run through the **PRE-CLEANING** sequence (**FILL**, **PUMP**, **DRAIN**, and **HARVEST**). If there is enough water in the sump at the start of **CLEAN**, it will go through a **DRAIN** sequence before **FILL**. The compressor will start during the **HARVEST** sequence to ensure there is no ice on the evaporator and will shut off before the cleaning sequence continues.

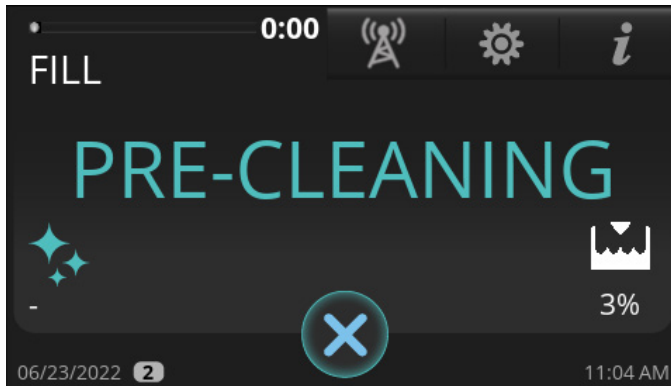

10. When **ADD SANITIZER** appears, open the water curtain and pour in 4.5 oz (133 mL) chlorine bleach (5.25% sodium hypochlorite) between the evaporator and the damper.

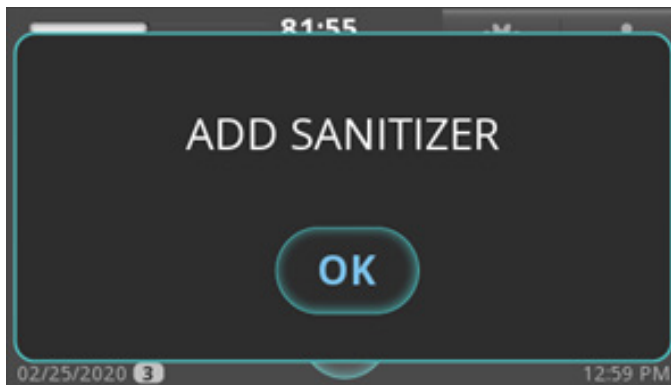

11. After adding chlorine bleach (5.25% sodium hypochlorite), press **OK**. The display will then show the sequence status. **NOTICE** The sequence will not proceed from this point unless **OK** is pressed after adding chlorine bleach (5.25% sodium hypochlorite).

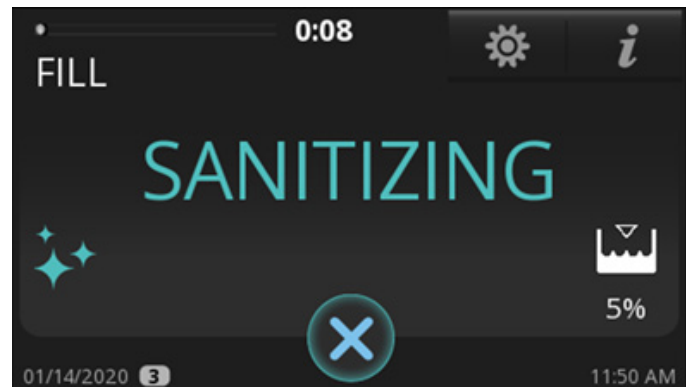

12. When the sanitizing sequence finishes, the ice machine will either go into **STANDBY** mode or return to **MAKE ICE** mode based on the choice made in step 8.

Maintenance & Servicing (cont.)

Preventative Maintenance Descaling & Sanitizing Procedure

⚠ DANGER!



HIGHLY CORROSIVE CLEANING CHEMICALS.
Avoid contact with eyes and skin. Wear eye protection and chemical-resistant rubber gloves when handling.

⚠ WARNING!



Toxic Material Hazard!
DO NOT MIX DESCALER WITH SANITIZER.
Harmful fumes may be generated.



Optical Radiation Hazard! UV Light!
Invisible laser radiation. Do not look directly at light. Always disconnect power before servicing the lamp.

ⓘ USER ACTION!



True recommends using TRUE Ice Machine Descaler. To purchase, contact True Parts Department at 800-424-8783 or partsinquiries@truemfg.com.

If using a non-TRUE descaler (Nickel-safe) recommended dilution for soaking parts is 3 fl oz (88.7 mL) per 1 gal (3.78 L) and recommended amount for evaporator cleaning is 6-8 fl oz (177.4-236.6 mL).

Use of non-recommended descaler may void warranty.

1. Loosen the front panel screws and open the front panel.
2. In the home screen, press **CLEAN** .

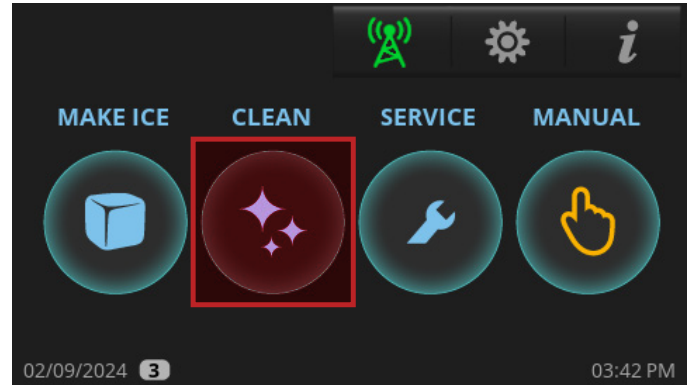

3. Press **BOTH**.



4. Press **PREVENTATIVE MAINT.**



Maintenance & Servicing (cont.)

Preventative Maintenance Descaling & Sanitizing Procedure (cont.)

- 5. When "Would you like the unit to start making ice once descaling and/or sanitizing is complete?" appears, press either **NO** or **YES**.

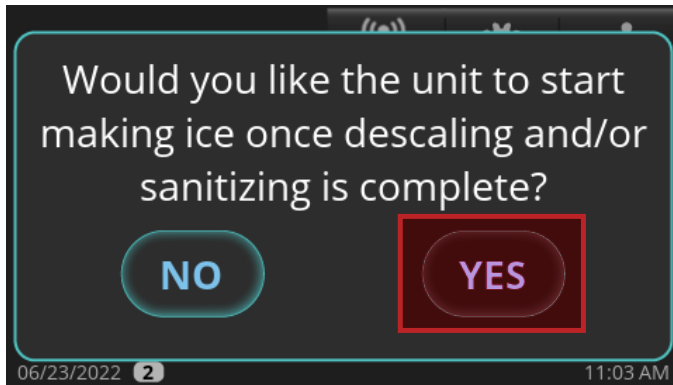

- 7. When **ADD CLEANER** appears, open the water curtain and pour in 10 oz (296 mL) of TRUE ice machine descaler between the evaporator and the damper.

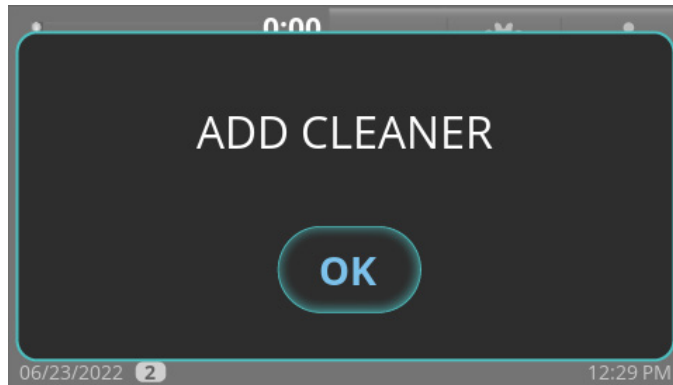

- 6. Wait for the ice machine to run through the **PRE-CLEANING** sequence (**FILL**, **PUMP**, **DRAIN**, and **HARVEST**). If there is enough water in the sump at the start of **CLEAN**, it will go through a **DRAIN** sequence before **FILL**. The compressor will start during the **HARVEST** sequence to ensure there is no ice on the evaporator and will shut off before the cleaning sequence continues.

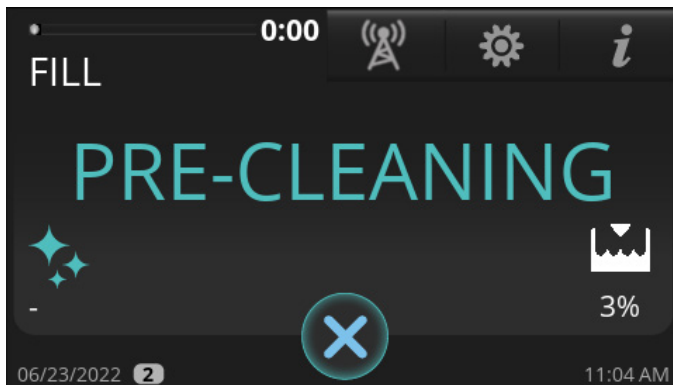

- 8. After adding the descaler, press OK. The display will then show the sequence status.

NOTICE > The sequence will not proceed from this point unless **OK** is pressed after adding the cleaner. When the procedure is finished, the ice machine will automatically enter the sanitizing sequence.

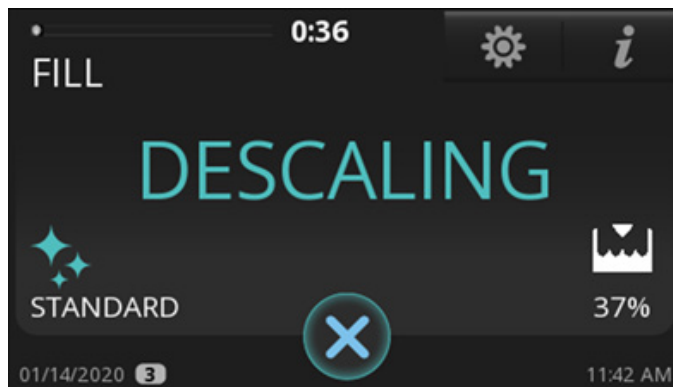

Maintenance & Servicing (cont.)

Preventative Maintenance Descaling & Sanitizing Procedure (cont.)

9. Let the ice machine finish the descaling sequence. When **ADD SANITIZER** appears, open the water curtain and pour in 1 oz (14.8 mL) chlorine bleach (5.25% sodium hypochlorite) between the evaporator and the damper.

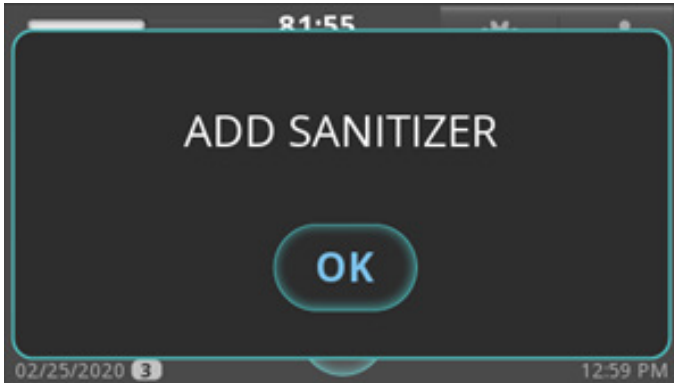

11. Let the ice machine finish the sanitizing sequence. Once the sanitizing sequence is complete, the ice machine will either go into **STANDBY** mode or return to **MAKE ICE** mode based on the choice made in Step 5.

10. After adding chlorine bleach (5.25% sodium hypochlorite), press **OK**. The display will then show the sequence status. **NOTICE** The sequence will not proceed from this point unless **OK** is pressed after adding chlorine bleach (5.25% sodium hypochlorite).

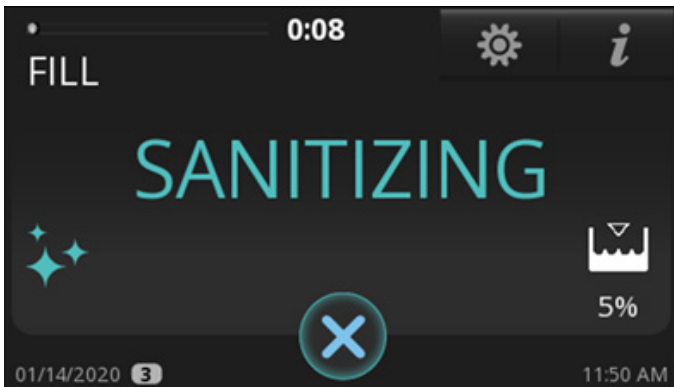

Maintenance & Servicing (cont.)

Troubleshooting

Before contacting a service provider, please check the items below.

General Troubleshooting Checklist		
Problem	Possible Cause	Possible Remedy
Ice machine does not come on, display is dark	No power supplied to the ice machine	<ul style="list-style-type: none"> Turn breaker on Replace blown fuse Turn disconnect on Check rocker switch
Ice machine does not come on, display is on	<ul style="list-style-type: none"> Ice machine scheduled to be off Ice machine turned off Ice machine off on alert 	<ul style="list-style-type: none"> Cancel schedule Press "Make Ice" icon Reset the ice machine by pressing the "Make Ice" icon until the ice machine beeps then press "Make Ice" icon again
Low production, ice is malformed or melted when it falls off the evaporator	<ul style="list-style-type: none"> Dirty evaporator Ice machine is not level 	<ul style="list-style-type: none"> Clean and sanitize the ice machine Level the ice machine
Low production, but ice looks normal	<ul style="list-style-type: none"> Dirty condenser High ambient air temperature 	<ul style="list-style-type: none"> Clean the condenser Reduce air temperature around the ice machine
Poor ice quality, cloudy and soft	<ul style="list-style-type: none"> Ice machine is dirty Poor quality water supply No water filtration Water softener problems (if applicable) 	<ul style="list-style-type: none"> Clean and sanitize the ice machine Contact company that can test the water supply and make water treatment recommendations Install water filtration Contact water softener manufacturer for service
Ice machine produces shallow or incomplete cubes, or the ice fill pattern on the evaporator is incomplete	<ul style="list-style-type: none"> Ice thickness is set too thin Not enough water in sump Hot water feeding ice machine Ice machine not level 	<ul style="list-style-type: none"> Adjust ice bridge thickness to 1/8" (3.18 mm) See "Adjust Ice Thickness" (pg. 50) Confirm water pressure is 20 psig (138 kPa) minimum, change water filter, clean water inlet valve screen Connect cold water supply line, call plumber if connected to hot water supply Level the ice machine

Maintenance & Servicing (cont.)

Troubleshooting (cont.)

Before contacting a service provider, please check the items below.

Ice Level Sensor Troubleshooting Checklist		
Problem	Possible Cause	Possible Remedy
Value is always 100%	<ul style="list-style-type: none"> Empty Bin Distance (EBD) and Full Bin Distance (FBD) set incorrectly 	<ul style="list-style-type: none"> Read Ice Level Sensor Setup Section (pg. 36) to setup EBD and FBD. Change EBD by 1 cm increments up to +/- 5 cm until Value changes. Change FBD by 1 cm increments up to +/- 3 cm until Value changes.
	<ul style="list-style-type: none"> Contaminant on lens 	<ul style="list-style-type: none"> Perform cleaning
	<ul style="list-style-type: none"> Sensor installed incorrectly 	<ul style="list-style-type: none"> Confirm sensor is sitting down in plastic case cutout
	<ul style="list-style-type: none"> Time of Flight (TOF) not enabled 	<ul style="list-style-type: none"> Ensure TOF = 1
Value is always 0%	<ul style="list-style-type: none"> EBD and FBD set incorrectly 	<ul style="list-style-type: none"> Read Ice Level Sensor Setup Section (pg. 36) to setup EBD and FBD. Change EBD by 1 cm increments up to +/- 5 cm until Value changes. Change FBD by 1 cm increments up to +/- 3 cm until Value changes.
	<ul style="list-style-type: none"> Sensor installed incorrectly 	<ul style="list-style-type: none"> Confirm sensor is sitting down in plastic case cutout

Maintenance & Servicing (cont.)

Alarm Codes			
CODE (1)	ALARMS ON 4.3" DISPLAY POP-UP	TYPE (2)	ENABLED IN (3)
E1	ALARM T1 Input	HW error (analog input)	always
E2	ALARM T2 Input	HW error (analog input)	always
E3	ALARM T3 Input	HW error (analog input)	always
E4	ALARM T4 Input	HW error (analog input)	always
E5	ALARM Air Filter Safety Switch Open	safety switch	run
E6	ALARM High Pressure Safety Switch Open	safety switch	always
E7	ALARM HP1 Input	HW error (analog input)	always
E8	ALARM LP1 Input	HW error (analog input)	always
E9	ALARM Water Level Sensor Input	HW error (analog input)	always
E11	ALARM Low Temperature T1 in Freeze	T1 < thr.	freeze
E12	ALARM High Temperature T1	T1 > thr. for time x	run
E13	ALARM Low Temperature T1	T1 < thr. for time x	run
E14	ALARM High Temperature T2	T2 > thr. for time x	run
E15	ALARM Low Temperature T2	T2 < thr. for time x	run
E16	ALARM High Temperature T3	T3 > thr. for time x	run
E17	ALARM Low Temperature T3	T3 < thr. for time x	run
E18	ALARM High Temperature T4	T4 > thr. for time x	run
E19	ALARM Low Temperature T4	T4 < thr. for time x	run
E20	ALARM High Pressure on HP1	P1 > thr.	run
E21	ALARM Drain Switch	drain switch status	always
E22	ALARM Long Freeze Time	Counter	freeze
E23	ALARM Calculation Error - Negative Value	WLEVEL < thr.	freeze
E24	ALARM Long Fill Time	timer fill > timeout	fill
E25	ALARM Long Purge Time	timer drain > timeout	drain
E26	ALARM Long Harvest Time	tim har > tout, or cnt	harvest
E27	ALARM Water Leakage	WLEVEL < thr. and cnt	freeze
E28	ALARM Pump Motor	WLEVEL > thr. and cnt	pmp tst
E29	H ₂ O Slow Fill - Check Water Connection	timer_fill > H ₂ O timeout	fill
E30	ALARM Biozone - Check Comm or Replace Bulb	Wrong data in Biozone	always
E31	ALARM Hot Gas Valve	HP1 pressure > thr.	harv; startup
E32	ALARM Low Suction Pressure	LP1 or LP2 < thr.	compr. ON
E33	ALARM HP2 Input	HW error (analog input)	always
E34	ALARM LP2 Input	HW error (analog input)	always

Warranty Information (USA & Canada Only)

Warranty Information

To view and download the
Warranty Information for USA & Canada,
please scan the QR code below.





[truemfg.com](https://www.truemfg.com)